

Version 8

Rig solutions for yachts ranging from 28 to 80 feet.



YACHT

PRODUCT CATALOGUE

INTERACTIVE CONTENTS

 **SELDÉN**
for sailing

PRODUCT CATALOGUES

We hope this Seldén Yacht product catalogue will be helpful for you finding accessories and spare parts for your rig. This is one of five product catalogues and it presents our range of products for approximately 28' to 80' yachts. They can all be downloaded from www.seldenmast.com.

Deck Hardware

Blocks, cleats, swivels, tracks, travellers, deck organizers and accessories.



Keelboat

Rig systems and accessories for 18 to 26 feet boats.



Dinghy

Rig systems and accessories for dinghies.

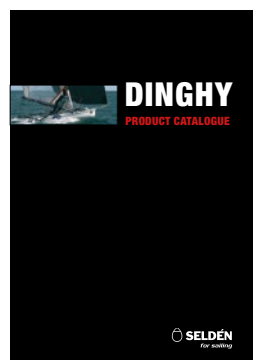

Carbon

Presents the entire carbon product range from dinghies to yachts.

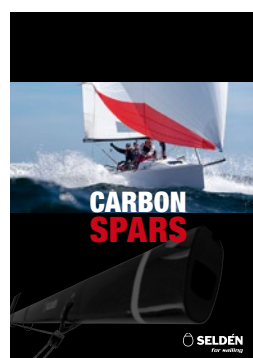

INTERACTIVE CONTENTS

CLICK TO NAVIGATE

Contents in alphabetical order	4
Introduction	6
Masts	10
Cross beams for catamaran	54
Booms and Rodkickers	56
Furling masts manual and electric drive	78
Furlex jib furling and reefing system	90
Seldén CX and GX	108
Hydraulic	118
Spinnaker and gennaker	132
Lights	158
Rig fittings	164
Just smart	183
Seldén worldwide. Useful publications.	190

Contents in alphabetical order

Click to navigate

A		D		Heel plug	46
Adapters for CX furlers	116	Dead end fitting	115	Hose clip	47
Adjustable tack swivel	117	Deck ring	45	Hydraulics	118-131
Anchor light, LED	160	Deck ring, for larger keel-stepped	51	Hydraulic cylinders	128
Anchor light, cables and dim.	162	Double fairlead	115	Hydraulic adjuster	128
Anti-twist shackle	116	E		I	
Anti-Torsion Cable	114	Electric Furling mast	86-89	Instrument bases	20
B		Endless furling line	114	Insulator, for backstays	181
Backing plate, for forestay	22,	Extension link, Furlex toggle	100	Inboard end	58
Backing plate, runners	29,	Extension link, Furlex electric	107	Inboard end, reef	66
Backing plate, for T-terminals	177	Extension link, toggles	178	J	
Backstay flicker	184	Eye terminal	174	Jam lever kit	70
Backstay tensioner	172	F		Jockey pole	136
Backstay tensioner, hydraulic	128	Flood light	161	Jockey pole eye	147
Block stand-up	46	Forestay fittings	21-23	Jockey pole fitting	150
Bolt rope extrusion	39	Fork terminal	174	Jumper arrangement	32
Boom brackets	67-69	Furlex Electric	104	L	
Boom sections, aluminium	58-59	Furlex H (Hydraulic)	126	Lazyjack slider	70
Boom selection	64-65	Furlex 50S (Standard)	92	Lazyjack system	184
Boom vang, hydraulic	129	Furlex 104S-404 (Standard)	94	Lifeline terminal	174
Bridle plate	181	Furlex TD (Through Deck)	102	Lifeline Pelican hook terminal	176
Bush pack	101	Furling mast luff extrusion	13	Light	159
Bridle kit	145	Furling mast luff extrusion	89	Light base	161
C		Furling mast specifications	88	Locking adhesive	188
Cable clamps for AT-Cable	115	Furling masts	78	Low friction shackle	116
Cable conduits	162	G		Lubricating grease	188
Cable glue	188	Gas spring	74	M	
Cable hose	49	Gennaker bowsprit	154	Main sheet slider	70
Cables	162	Genoa box	22-27	Mast coat	47
Carbon fibre mast	14-17	Grease hole cover	89	Mast coat, larger keel stepped	51
Cleat	52	GX, Gennaker furlers	109	Mast heels	46
Clevis pins	179-180	H		Mast jack system	120
Climbing step	186	Halyard lead	22-27	Mast sections, aluminium	12
Control panels, hydraulics	130	Halyard routing	24	Mast sections, carbon	17
Covers and plugs, furl. mast	89	Halyard tensioner	172	Mast step	186
Cross beam for catamaran	54-55	Headbox	18	Match racing boom	59
Cutter stay arrangements	29, 31	Headbox fittings	20	MDS full-batten system	40-41
Cutter stay stowage	186	Heel lift system	152		
CX, Code 0 furlers	108				

N				
Nose tang fitting	23			
O				
O-Fittings	22			
Outhaul tracks, retrofit	70			
P				
Plug	89			
Pop rivet	188			
Pop rivet gun	188			
R				
Reefing pad	52			
Rigging screw	166-171			
Rigging screw cover	173			
with PVC top-plug	185			
Rigging screw oil	171			
Rigging screw oil	188			
Rigid vang	72			
Ring slider	149			
Rod forestay	101			
Rodkicker	72			
Rodkicker boom bracket	77			
Rodkicker mast bracket	75-76			
Rubber chocking	46			
Running backstay attachments	29			
S				
Sail entry	39			
Sail slides	12			
Sealing kit	188			
Sheave boxes	25			
Sheaves	181			
S-Hook	62			
Single Line reef	62-63			
Single Line reef kit	70			
Slab reef	62			
Sliding insert	149			
Slot fittings	25			
Spinnaker box	22-25			
Spinnaker halyard attachment	146			
Spinnaker pole	132-153			
Spinnaker pole attachment	147			
Spinnaker pole car	149			
Spinnaker pole fitting	150			
Spinnaker pole kit	144-145			
Spinnaker pole slider	149			
Spinnaker stowage bracket	152			
Split pin	179-180			
Split ring	180			
Spreader brackets	34			
Spreader ends	32			
Spreader, assemblies	34			
Spreaders	30-37			
Stanchion block	189			
Steaming light	160			
Stemball terminals, for spreaders	37			
Stemball terminals, for rig. screw.	175			
Stopper pad	52			
Stud,Sta-lok	176			
Stud	174			
T				
T/Eye toggle	29			
T-Base	48			
Telescopic pole	136			
Terminals, for spreader	36			
Terminals, for rig fittings	174-177			
Thimbles for AT-cables	115			
Tie rod	47			
Toggles, forestay and backstay	21			
Toggles, T-eye rope	29			
Toggles for Furlex	100			
Toggles, fittings	176			
Toggles	178			
Tricolour lamp	160			
Trip line exit box	145			
Trip trigger	134-144			
Trip trigger, pole fittings	150			
Triple combi box	22			
Trysail system	187			
T-terminals	177			
T-terminal backing plates	177			
Twaron protection	145			
V				
Vertical pole stowage	153			
W				
Wedgings	44			
Wedge, Sta-lok	176			
Whisker pole	141-143			
Winch handle pocket	189			
Winch pad	52			
Windex base	20			
Windex crane	20			
Windex extension	20			
Windex light	160			
Wire terminal	176			



DINGHIESKEELBOATSYACHTS

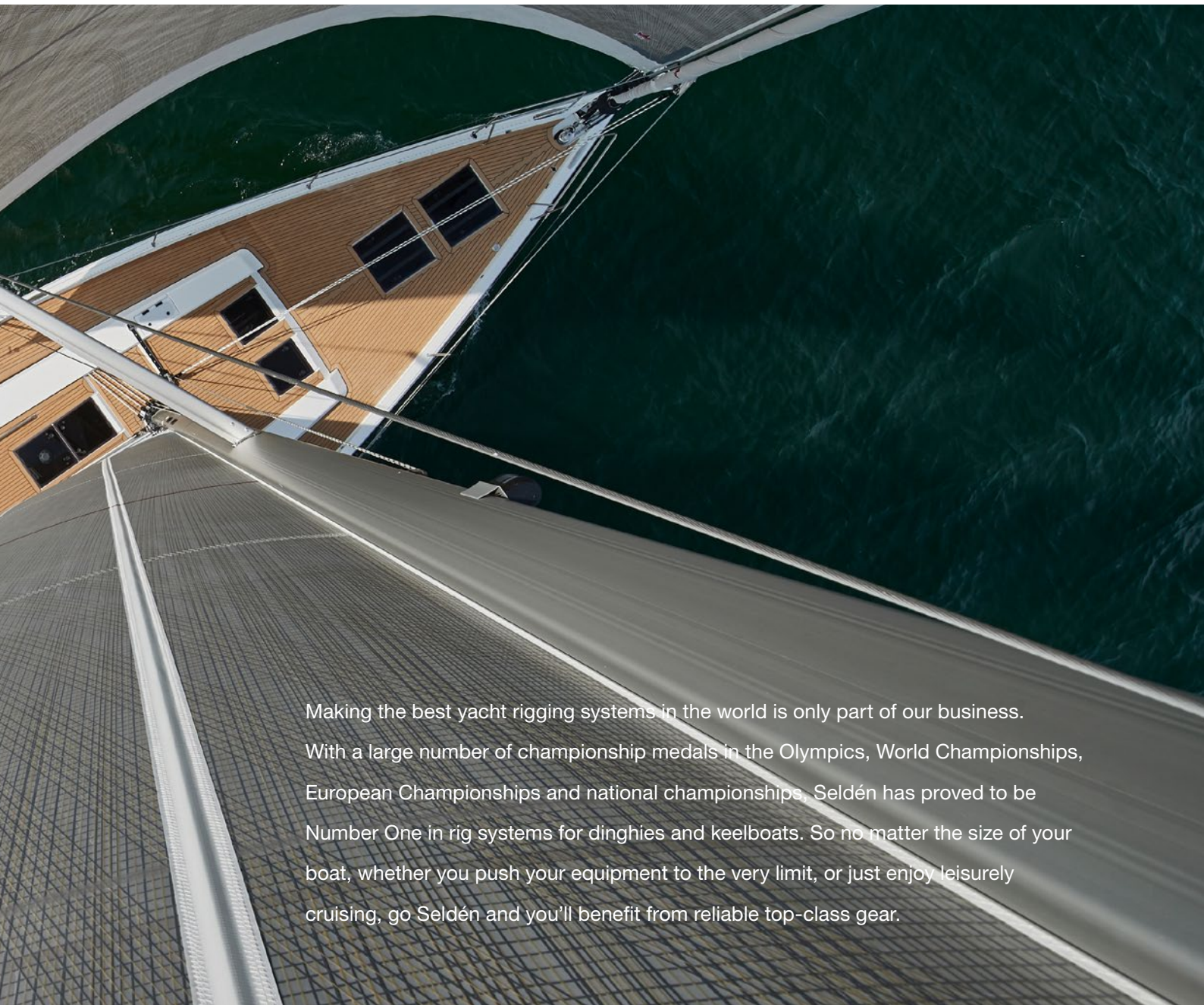

Making the best yacht rigging systems in the world is only part of our business. With a large number of championship medals in the Olympics, World Championships, European Championships and national championships, Seldén has proved to be Number One in rig systems for dinghies and keelboats. So no matter the size of your boat, whether you push your equipment to the very limit, or just enjoy leisurely cruising, go Seldén and you'll benefit from reliable top-class gear.

Right from the start



Heeling test in 1965. The righting moment of the boat is measured at 30° heel.

Seldén was founded in 1960 and it has grown from a small company into the world leader, with manufacturing in Europe, the USA and Asia. Precise, meticulous work has always been a characteristic of Seldén. Our manufacturing methods, tools and instruments have been specially developed to meet the demands of large-scale, cost-effective, quality production and the high demands of sailors around the world. However, we still carry out the same heeling tests as we did back in 1965. We started by doing things in the right way, and that is how we have continued.



Heeling test today. Materials change. Good methods don't.

Unspecified changes can cause failures

Each rig is carefully designed and sized for the boat in question. We base our mathematical dimensioning on the righting moment of the boat and the boat designer's proposed sail plan. The wishes of the boat owner determine the way the rigging system is equipped. With nearly 50 years of experience, we have built up a tremendous experience bank for the use of our rig designers. As a result, the boat and rig form a well-functioning whole. Because of this, it is important that even seemingly unimportant details on the boat or rig are not changed without first consulting us, as even small changes can lead to big problems.

Each mast and boom from Seldén has a unique serial number. This is engraved in the lower end of the mast extrusion and the front end of the boom extrusion. Quote this number if you want to discuss details relating to your rig.

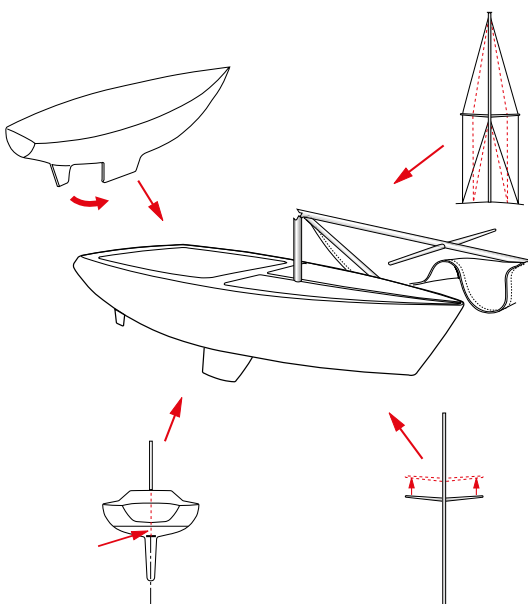



Give us the facts

The key to a correct rig calculation is the quality of the input data at our disposal. This data consists of hard facts, plus what we can learn by listening very carefully when talking to the customer.

The “Seldén Rig Fact sheet” has proven to be a simple and effective way of gathering all the facts required to calculate the mast, boom and standing rigging. It is where you note the data on the envisaged type of rigging, the main dimensions of the sail plan, the location of the chainplates and the righting moment of the boat (or the correct information to help us calculate the righting moment). The “Seldén Rig Fact sheet” is available on our web site, www.seldenmast.com.

Attention to detail

In our search for perfection, no detail is considered too small. This applies to everything, from the choice of materials to stringent testing of the finished product. Seldén’s business philosophy can be summed up as quality thinking and system thinking, and a continuous quest to achieve the best possible function for each product. This catalogue provides an overview of this holistic approach. Read on to learn about our MDS full-batten system, our unique inboard ends, the load distributors in the Furlex jib furling system, and a great many other features and details.

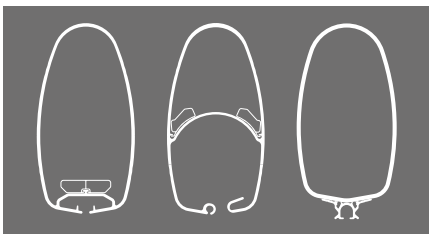

Attention to detail

Every Seldén rig is carefully thought out, down to the last detail. Each individual component contributes to the performance of the whole rig. That is the Seldén way – experienced yachtsmen behind every aspect of design, product development and production.

MASTS



Mast sections	12
Seldén carbon spars	14
Headboxes	18
Forestay and backstay toggles	21
Forestay fittings and halyard routing	22
Running backstay attachments	31
Spreaders	32
Sail entry	39
Full-batten system, IWS	38
Full-batten system, MDS	40
Full-batten system, RCB	42
Keel-stepped and deck-stepped masts	44
Deck ring system	50
Winch pads	52
Cleats	52

Custom made is our standard

Seldén has earned its reputation as the world leader in aluminium masts for conventional sail handling as well as for main sail furling. Today, Seldén offers a full range of masts and rig equipment in both aluminium and carbon. All rigs are custom-made for each individual boat. We know how much depends on the rig, and there is no room for compromise.

Mast sections

C-sections and F-sections

Longitudinal oriented mast sections

Loads generated by the crew (mainsheet, vang, outhaul, Cunningham etc.) are transferred to the mainsail and on to the mast. As the mainsail is designed according to the expected curve of the mast, a longitudinally stiff mast allows for less luff curve of the sail. Instead, this sail area can be added to the roach of the sail, where it is subjected to the wind and more efficient. The longitudinal rigidity of the mast section makes for higher forestay load created by tensioning the backstay. Running backstays can often be avoided. The risk of mast pumping is also reduced.

Lateral oriented mast sections

The new C137 & C153 mast profiles have been designed to provide a solution for the modern, swept spreader rig arrangements. The developing trends for large spreader sweep angles, enables the rig to rely less on the mast section to provide longitudinal inertia (stiffness) allowing material and ultimately weight to be removed from the profile. The new sections are also suitable for 1-spreader rigs on 26' to 32' boats.



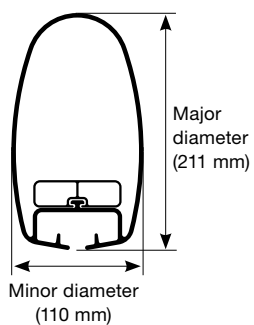

Mast section measurements are given as follows: Major diameter/Minor diameter (i.e. 211/110). This will help identification and the use of correct measurements. The major diameter of the mast can usually be found in the number engraved at the mast heel. For example K23-C211-4475.

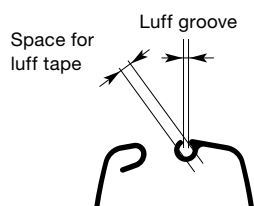

Furling mast luff extrusion				
	Weight kg/m	A mm	B mm	
RA	0.55	2.8 ±0.25	6.0	
RB	0.93	3.25 ±0.35	8.0	
RC	1.28	3.25 ±0.25	10.6	
RD	2.11	3.25 ±0.25	10.6	

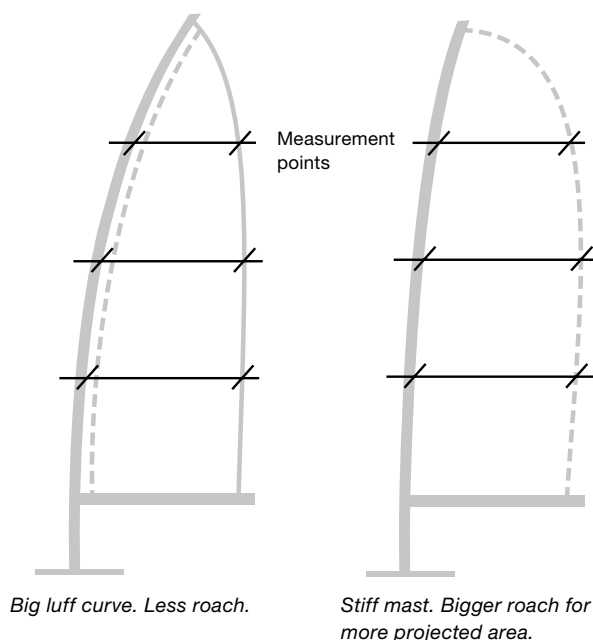

	Mast section	Section dim. mm	I _y cm ⁴	I _x cm ⁴	Wall thickness mm	Weight kg/m	W _y cm ³	W _x cm ³	Sail groove mm	Sail groove for bolt rope*	Car	Sail slides Art. no.																																																																																																																																																																																																										
C-sections	C137	138/98	267	138	2,8	3,02	34,7	28,2	10,5 ± 0.7	-	IWS 45	511-605																																																																																																																																																																																																										
	C153	153/107	369	186	2,9	3,34	43,5	34,9					C-sections	C156	156/87	391	144	3,00	3,71	42,8	33,2	10 ± 0.75	5.5 ± 0.75	MDS	511-605 or 511-607	C175	175/93	558	191	3,24	4,18	53,6	41,0	C193	193/102	779	257	3,40	4,74	69,3	50,6	C211	211/110	1051	341	3,65	5,34	86,5	62,0	C227	227/119	1407	456	3,95	6,15	108,0	76,6	C245	245/127	1910	614	4,35	7,15	137,0	96,5	C264	264/136	2591	830	4,80	8,40	172,0	122,0	C285	285/147	3508	1127	5,20	9,72	214,0	153,3	C304	304/157	4686	1524	5,80	11,44	272,0	194,0	C321	321/171	5822	2056	5,5/6,4	13,06	324,4	238,7	16 ± 0.75			511-603	C365	365/194	9160	3161	5,5/6,8	15,50	447,0	326,3					F-sections	RA	F176	176/93	526	187	2,89	4,20	58,2	40,0	See table page 10.**				F194	194/101	709	254	3,04	4,79	70,8	49,8	RA/RB	F212	212/109	970	337	3,15	5,49	88,2	61,8	RA/RB	F228	228/118	1306	453	3,40	6,35	112,0	76,8	RB	F246	246/126	1781	613	3,75	7,44	139,0	97,3	RB/RC	F265	265/135	2392	828	4,15	8,73	173,0	122,0	RB/RC	F286	286/146	3237	1122	4,50	10,10	220,0	154,0	RB/RC	F305	305/156	4389	1513	5,05	11,84	276,0	194,0	RC/RD	F324	324/169	5576	2056	5,5/7,0	13,80	328,8	243,3	RD	F370	370/192	8835	3149	5,8/9,0	16,60	468,0	326,0	RD	F406	408/207	14321	4725	6,5/10,0	21,20
C-sections	C156	156/87	391	144	3,00	3,71	42,8	33,2	10 ± 0.75	5.5 ± 0.75	MDS	511-605 or 511-607																																																																																																																																																																																																										
	C175	175/93	558	191	3,24	4,18	53,6	41,0																																																																																																																																																																																																														
	C193	193/102	779	257	3,40	4,74	69,3	50,6																																																																																																																																																																																																														
	C211	211/110	1051	341	3,65	5,34	86,5	62,0																																																																																																																																																																																																														
	C227	227/119	1407	456	3,95	6,15	108,0	76,6																																																																																																																																																																																																														
	C245	245/127	1910	614	4,35	7,15	137,0	96,5																																																																																																																																																																																																														
	C264	264/136	2591	830	4,80	8,40	172,0	122,0																																																																																																																																																																																																														
	C285	285/147	3508	1127	5,20	9,72	214,0	153,3																																																																																																																																																																																																														
	C304	304/157	4686	1524	5,80	11,44	272,0	194,0																																																																																																																																																																																																														
	C321	321/171	5822	2056	5,5/6,4	13,06	324,4	238,7	16 ± 0.75			511-603																																																																																																																																																																																																										
C365	365/194	9160	3161	5,5/6,8	15,50	447,0	326,3																																																																																																																																																																																																															
F-sections	RA	F176	176/93	526	187	2,89	4,20	58,2	40,0	See table page 10.**																																																																																																																																																																																																												
		F194	194/101	709	254	3,04	4,79	70,8	49,8																																																																																																																																																																																																													
	RA/RB	F212	212/109	970	337	3,15	5,49	88,2	61,8																																																																																																																																																																																																													
	RA/RB	F228	228/118	1306	453	3,40	6,35	112,0	76,8																																																																																																																																																																																																													
	RB	F246	246/126	1781	613	3,75	7,44	139,0	97,3																																																																																																																																																																																																													
	RB/RC	F265	265/135	2392	828	4,15	8,73	173,0	122,0																																																																																																																																																																																																													
	RB/RC	F286	286/146	3237	1122	4,50	10,10	220,0	154,0																																																																																																																																																																																																													
	RB/RC	F305	305/156	4389	1513	5,05	11,84	276,0	194,0																																																																																																																																																																																																													
	RC/RD	F324	324/169	5576	2056	5,5/7,0	13,80	328,8	243,3																																																																																																																																																																																																													
	RD	F370	370/192	8835	3149	5,8/9,0	16,60	468,0	326,0																																																																																																																																																																																																													
RD	F406	408/207	14321	4725	6,5/10,0	21,20	671,0	451,0																																																																																																																																																																																																														

* If a traditional bolt rope is to be used, a plastic profile (Art. No. 535-710), as well as a sail feed (505-526-01) must be added to the luff-groove on the mast.

** For more detailed information on Seldén's furling masts, see pages 79-89 or "Sailmakers' Guide" (www.seldenmast.com).

MORE SPEED WITH FAST FIBRES

**Seldén carbon fibre masts – the perfect mix
of craftsmanship and modern production technology**



Our carbon spars are designed using the latest finite element analysis backed by many years of solid engineering experience.

Our unique production method gives a unique look. We call it Mandrel Filament Moulding (MFM). The process is fully automated and computer controlled for ultimate accuracy, repeatability, efficiency and that stunning 'Viper' pattern.

Seldén produce over 400 carbon masts per year as well as booms, poles and bow sprits for boats including high performance skiffs, racing keelboats, IRC race boats and some of the world's most prestigious cruising yachts. With more sailors choosing Seldén carbon spars, the pattern is obvious.

For more detailed information, please see our Carbon catalogue.



Seldén carbon spars

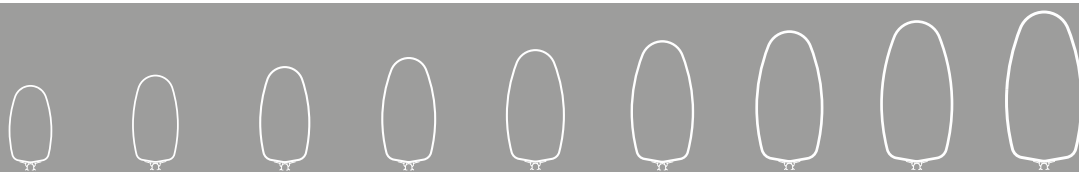

For everyone who cannot resist speed

Carbon composite combines stiffness and strength with low weight. Seldén low-weight carbon spars have accentuated longitudinal stiffness. This means that forestay tension can be substantially increased. All experienced racing sailors know what this means in terms of increased upwind performance. The combination of greater stiffness and reduced weight will bring you beyond the speed limits.



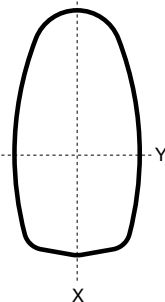

Mast section	Section dim. mm	EI_y GNmm ²	EI_x GNmm ²	Wall thickness mm	Weight kg/m	W_y cm ³	W_x cm ³
CC154-30	157/87	230	92	3,0	1,8	40	30
CC154-36	158/88	292	117	3,6	2,2	49	37
CC174-30	177/93	325	120	3,0	2,0	51	37
CC174-36	178/94	411	152	3,6	2,4	61	44
CC192-36	195/102	533	194	3,6	2,6	72	52
CC192-42	196/103	644	235	4,2	3,1	85	61
CC210-36	213/110	688	242	3,6	2,9	85	61
CC210-42	214/111	832	293	4,2	3,4	100	71
CC226-36	228/118	849	301	3,6	3,1	98	70
CC226-42	229/119	1025	365	4,2	3,6	115	82
CC244-42	247/127	1282	448	4,2	3,9	134	95
CC244-48	248/128	1503	527	4,8	4,5	153	109
CC263-42	265/135	1574	542	4,2	4,2	154	108
CC263-48	266/136	1844	638	4,8	4,8	176	124
CC263-54	267/137	2116	735	5,4	5,4	199	140
CC303-54	306/156	3203	1107	5,4	6,2	262	185
CC303-60	307/158	3613	1253	6,0	6,9	292	206
CC364-66	365/193	6837	2445	6,6	9,7	459	326
CC364-72	366/194	7531	2707	7,2	10,6	502	357

Black pigment in the epoxy protects against UV radiation. Clear varnish, or paint, provide extra UV protection and preserves the exclusive appearance.



Headbox

C211-C304 and F212-F406

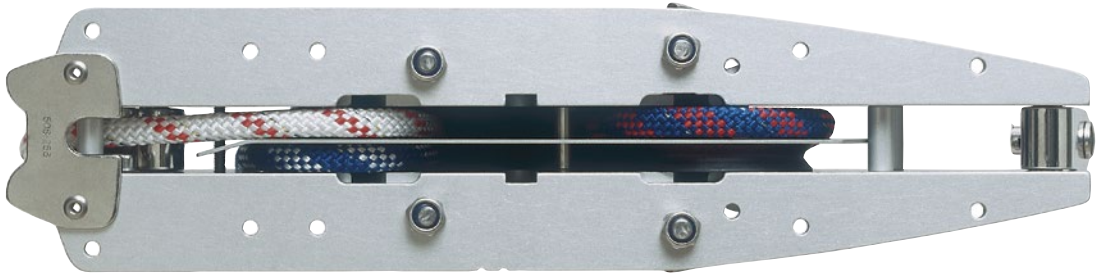

The headboxes are equipped with a separator, to make it easy to access the top sheaves. Just loosen the separator, which also works as a locking plate, and the sheaves can easily be lifted up for inspection or replacement. This means that you can replace the sheaves without unstepping the mast and removing the headbox. The separator is slightly angled at its front end to lead the spinnaker halyard on to the sheave. The headbox fitting has a gently rounded halyard lead for a masthead spinnaker or gennaker. Conventional spinnaker arrangement with one or two halyard blocks is, of course, still an option.

An instrument base is available for both straight and angled tops. The instrument base is designed to make it easy to dismantle the mid section when you need to access the mast top sheaves.



Well organised and easily accessible.



Separator locks sheaves and also controls spinnaker halyard.













Top access, without unstepping the mast and removing the headbox.

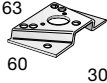

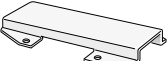
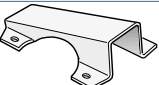
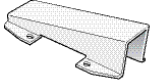
Mid section of instrument base easily removed to access top sheaves.

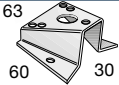
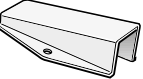
Headbox fittings

	Art. No.	Description	Dimensions length x width mm	Notes
	508-268-01	Instrument base	197 x 74	For 0° headbox Fractional rig C211-C304 Masthead rig C175-C285, F176-F286
	508-268-02	Instrument base	197 x 74	For 15° headbox C211-C304, F194-F305
	508-314-01	Aerial bracket assy	155x86x20	For 0° headbox
	508-521-01	Windex crane	136 x 74	Incl. pop rivets (4.8 x 16.5) to be fitted on aft edge of headbox. For 15° headboxes, bend crane for horizontal position.
	508-558	Windex base on top of "Aqua" tricolour (white) lamp.	Ø 58	
	508-562-01	For tricolour lamp and anchor light.	60 x 30 x 63	For 0° headbox All sections
	508-526-01	Instrument base	100 x 55	For 0° headbox All sections
	508-561-01	Instrument base	180 x 65	For 0° headbox All sections
	508-527-01	Instrument base	105 x 55	For 15° headbox All sections
	508-541-01	Instrument base	180 x 65	For 15° headbox All sections
	508-549-01	Windex and anchor light base.	20 x 30	For 15° headbox All sections
	508-551-01	Windex extension	60	
	508-560-01	Bases for tricolour lamp and anchor light.	60 x 30 x 63	For 15° headbox All sections (except C304 and F305)
	508-563-01	Instrument base	100 x 40	For 15° headbox All sections (except C304 and F305)
	508-176-02	2 port and starboard wings with support strut.	Length = 500 mm	For 0° headbox without base. For 15° headbox shall base 508-541 be used.

Forestay and backstay toggles

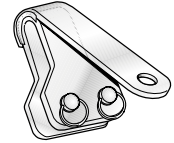
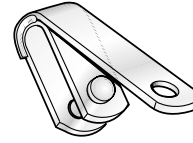
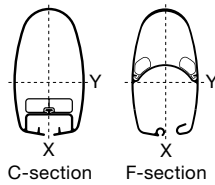

S = Single toggle D = Double toggle

S = Single toggle D = Double toggle

C-sections and F-sections

Wire dia. mm	Mast section	Forestay and backstay toggle				Art. No.	Max. triatic-wire dia.
		Art. No.	Width mm	Masthead mm	Term. pin (bush) dia. mm		
4	C156	517-001-01 S	30	10	8		
5	C156, C175, F176	517-001-01 S	30	10	8		
	C193, F194	517-003-01 D	30	10	10		
6	C156, C175, F176	517-046-01 S	30	12	10		
	C193, F194, C211	517-006-01 D	30	12	10		
	F212, C227, F228						
	C245, F246, C264	517-046-04 S	39	12	10		
	F265						
7	C175, F176, C193	517-004-01 S	30	14	12	517-012-01 S	6
	F194, C211, C211 Tpr	517-006-01 D	30	14	12	517-014-01 D	6
	C227, C227 Tpr						
	C245, F246, C 264	517-048-03 S	36	14	12		
	F265						
8	C245, F246, C285	517-048-01 S	36	14	14		
	F286, C245 Tpr	517-009-01 D	38	16	16		
	C264 Tpr, C285 Tpr						
	C245, F246, C264	517-060-03 S	38	16	16	517-015-01 S	6
	F265, C285, F286	517-009-01 D	38	16	16	517-016-01 D	6
	C304, F305						
	C175, F176, C193	517-005-01 S	30	14	14	517-013-01 S	6
	F194, C211, F212	517-006-01 D	30	14	12		
	C227, F228						
10	C211, F212, C 227	517-005-01 S	30	14	14	517-013-01 S	6
	F228						
	C245, F246, C264	517-060-03 S	38	16	16	517-015-01 S	6
	F265, C285, F286	517-009-01 D	38	16	16	517-016-01 D	6
	C304, F305	517-017-01 S	47	20	16		
		517-019-01 D	47	20	16		
12	C245, F246, C 264	517-026-01 S	38	16	19	517-028-01 S	6
	F265, C285, F286	517-027-01 D	38	16	19	517-029-01 D	6
	C304, F305, C321, F324	517-052-01 S	47	20	19		
		517-020-01 D	47	22	19		
14	C304, F305, C321, F324	517-053-01 S	47	22	22		
		517-058-01 D	49	22	22		

Tpr = Tapered top

Forestay fittings and halyard routing

Cutter stay on masthead rigs

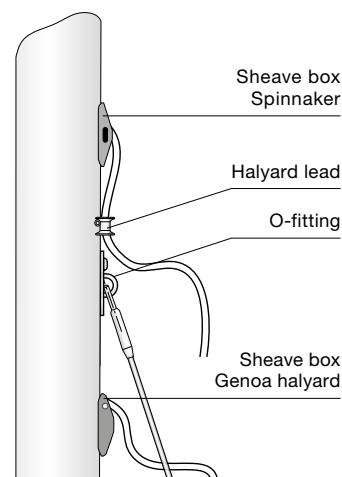
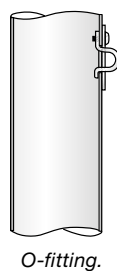
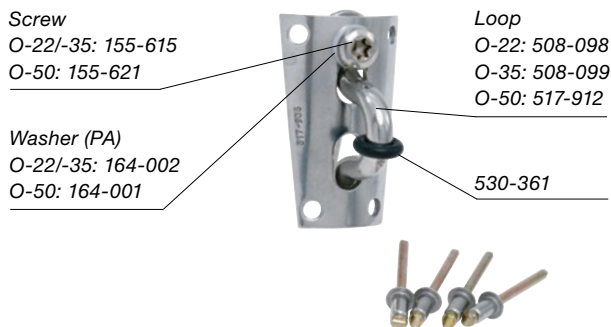

O-fittings

Wire dia. mm	Fitting	Art. No.	Limits	To be combined with...					
				Genoa box single	Genoa box double	Spinnaker box single	Spinnaker box double	Single halyard load	Double halyard lead
4 5	O-22	517-904-01	Max F212, C245 R232, R260 R290	505-004-10	505-053-01	505-004-10	505-053-01	508-159-01	2 x 508-159-01
6	O-35	517-905-01		505-016-10		505-016-10			
7	O-50	517-911-01	Max F212, C264 Ej E274, R232, R260, R290			505-015-10			508-120-01 or 508-734-01*
8	O-50	517-911-01	Max C227	505-015-10	505-059-01		505-059-01		

For more information about halyard leads, see page 26.

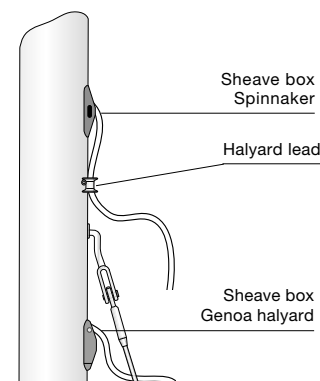
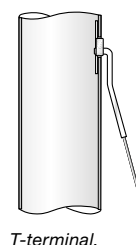

Backing plates for T-terminals, forestay applications

(Backing plates for lateral rigging, see page 173)

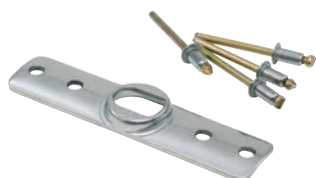

Note. Never put a forestay fitting or a halyard box in the tapered area. Applies to masts with E-sections where the weld for the taper is on the forward side of the mast.

Wire dia. mm	Art. No.	To be combined with...					
		Genoa box single	Genoa box double	Spinnaker box single	Spinnaker box double	Single halyard lead	Double halyard lead
3	507-553-01*	505-004-10	505-053-01	505-072-01	505-053-01	508-159-01	2 x 508-159-01
4	507-551-01*						
5	507-552-01*						
6	507-560-01*	505-016-10		505-016-10			
6/R-sections	507-600-02*						
7				505-015-10			508-120-01 or 508-734-01**
7/E274	507-601-01						
8/E274	507-582-01						

* Min F176

** Intended only for rope (not rope/wire).

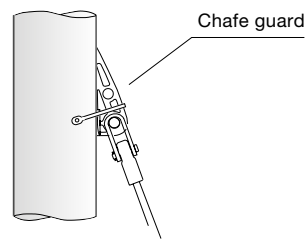

Nose tang with chafe guard. To be used where the halyard is led above the nose tang. On fractional rigs with a single box for the spinnaker halyard, a good solution is to have its lead block attached to the forestay fitting. Seldén offers complete kits with forestay fitting, including the appropriate lead block. Seldén also offers sheave box kits complete with fasteners.

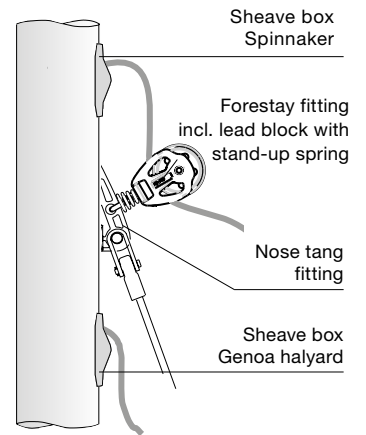

Nose tang fittings, incl. toggle

Wire dia. mm	Description	Art. No.	Toggle length mm	To be combined with...						Single halyard lead	Double halyard lead
				Spring for spinnaker block	Genoa box single	Genoa box double	Spinnaker box single	Spinnaker box double			
6	Nose tang fitting/toggle	517-923-03	40	308-074	505-016-10	505-053-01	505-016-10	505-053-01	508-159-01 or 508-847-01	2x 508-159-01 or 508-734-01*	
	Nose tang fitting/toggle/chafe guard	517-923-07									
	Nose tang fitting/toggle/lead block	517-923-01									
7	Nose tang fitting/toggle	517-923-04									
	Nose tang fitting/toggle/chafe guard	517-923-08									
	Nose tang fitting/toggle/lead block	517-923-02									
8	Nose tang fitting/toggle	517-924-03	50		505-015-10	505-059-01	505-015-10	505-059-01		2x 508-128-01 or 508-735-01*	
	Nose tang fitting/toggle/chafe guard	517-924-05									
	Nose tang fitting/toggle/lead block	517-924-08									
10	Nose tang fitting/toggle	517-924-04	55		505-015-10			505-059-01	508-128-01 or 508-848-01		
	Nose tang fitting/toggle/chafe guard	517-924-06									
	Nose tang fitting/toggle/lead block	517-924-09									
12	Nose tang fitting/toggle	517-925-02	65	308-037	505-015-10 RM<120 kNm	505-059-01 RM<120 kNm	505-038-01 RM<120 kNm	505-051-01 RM<120 kNm		2x 508-128-01** or 508-839-01	
	Nose tang fitting/toggle/chafe guard	517-925-03									
	Nose tang fitting/toggle/lead block	517-925-05									
14	Nose tang fitting/toggle	517-915-02	80		505-038-01	505-051-01	505-038-02 RM<160 kNm	505-051-02 RM<160 kNm			
	Nose tang fitting/toggle/chafe guard	517-915-03									
16	Nose tang fitting/toggle	517-942-02		-	508-038-02	505-051-02	505-116-01	505-113-01	-	508-837-01	
	Nose tang fitting/toggle/chafe guard	517-942-03									

* Intended only for rope (not rope/wire). ** Only to control genoa halyards.

The routing of halyards is always important, but particularly so on yachts with jib furling and reefing systems.

A properly installed halyard box provides optimum halyard routing. Seldén offers a complete range of halyard boxes. You can choose between our range of single- or double halyard boxes shown in the table on the next page. You can also use halyard leads (see below).

Seldén halyard leads are made from chromed bronze, so that the relatively soft bronze will not damage a stainless steel wire halyard. The halyard leads are easily retrofitted to an existing mast.

On yachts with furling systems, correct halyard routing ensures that the halyard does not wrap around the fore-stay extrusion when furling the foresail.

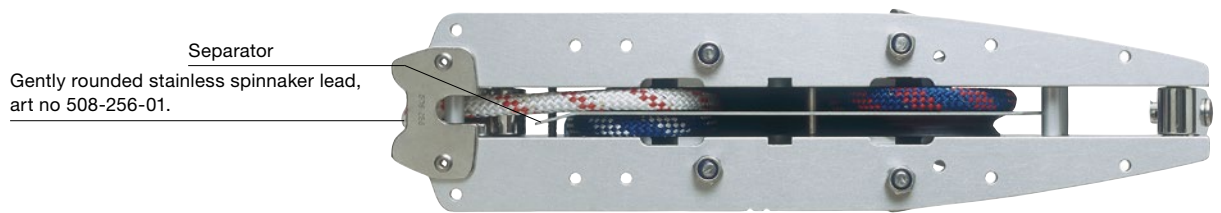

Gently rounded stainless spinnaker lead, art no 508-256-01.

Masthead headbox for C211-C301 and F212-F406. The headbox fitting has a gently rounded lead for a masthead spinnaker and gennaker. The separator is slightly angled at its front end to lead the halyard on to the sheave.

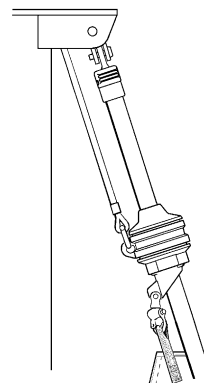
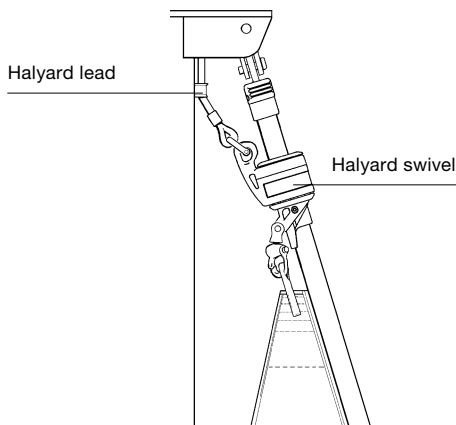

Unproper halyard routing leads to...

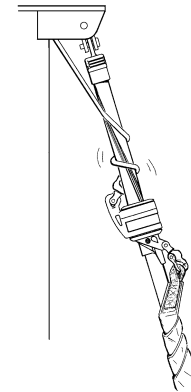

... halyard wrap!

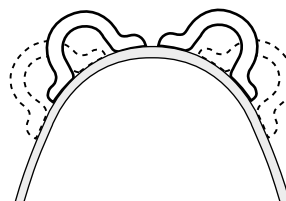
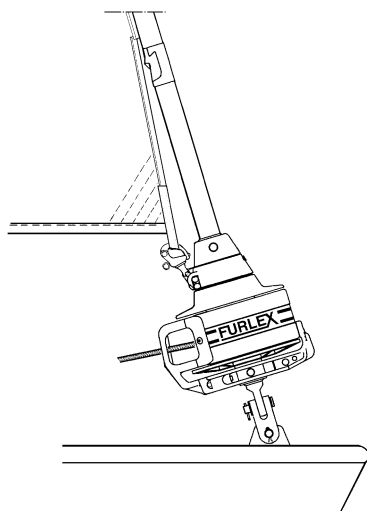

The halyard leads can be fitted side by side or moved round the side of the mast if there is a lack of space

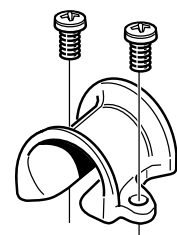

The halyard leads come with an insulating sheet and fasteners.

Sheave boxes, slot fittings

Max rope dia., mm	Max Wire/rope dia., mm	Description	Art. No.	Pin safe work load, kN	Width of slot	Remark
8	-	Sheave box 35 x 10 (composite), screw fix	505-061-02	7		
8	-	Sheave box 35 x 10 (composite), rivet fix	505-061-03	7		
12	-	Sheave box 45 x 13 (composite), rivet fix	505-072-01	8		
12	10/4	AL-45 kit	505-004-10	8		Min C156
12	10/5	AL-70 kit	505-016-10	12		Min F176
12	10/5	C70 kit* (composite)	505-067-10	15		Min C156
12	10/5	Double sheave box Ø 70 x 13 (AL, pop rivets)	505-053-01	12		Min F194 Min C156
12	10/5	Double sheave box Ø 70 x 13 (AL, screws)	505-053-03	12		Min F194 Min C156
16	14/7	AL-90 kit	505-015-10	25		Min F212
16	14/7	Double sheave box Ø 90 x 16 (AL)	505-059-01	25		Min F228
20	16/8	Sheave box Ø 130 x 20, aft (ST)	505-038-01	25		Min F286
20	16/8	Sheave box Ø 130 x 20, aft, extra wide (ST)	505-055-01	25		Min F286
20	16/8	Double sheave box Ø 130 x 20, aft (ST)	505-051-01	25		Min F324
20	16/8	Sheave box Ø 130 x 20, forward (ST)	505-042-01	25		Min F286
20	16/8	Sheave box Ø 130 x 20, aft (ST)	505-038-02	32		Min F286
8	8/4	Slot fitting, small (ST)	505-017-01		10	
14	12/5	Slot fitting, medium (ST)	505-014-01		14	
16	14/7	Slot fitting, large (ST)	505-021-01		18	
20	16/8	Slot fitting, x-large (ST)	505-025-01		24	

* Spinnaker halyard/lift box; always combine with halyard lead.

AL = Aluminium

ST = Stainless steel



AL-45, Art. No. 505-004-10.



AL-70, Art. No. 505-016-10.



AL-90, Art. No. 505-015-10.

Available as complete kits including fasteners and assembly instructions.



The "aft" sheave box is fitted above the "forward" sheave box in order to avoid halyard wear.



Slot fittings reduce friction and avoid wear from the wire halyards on the mast extrusion.

Halyard leads

Fitted below a halyard box, the halyard lead prevents a spinnaker halyard, gennaker halyard or Code 0 halyard from chafing against the edges of the box. Also used to lead a jib halyard correctly from a furling system to the halyard box preventing halyard wrap.

Max. dia., mm			Max RM Fractional kNm	Max RM Top hoisted kNm	Remarks
Rope	Wire/rope	Halyard lead Art. No.			
12	10/5	508-159-03R	13	15	Single halyard lead in chromed bronze, including Ø 5.3 mm self-tapping screws and insulating plate. Not to be used for a Code 0 halyard.
20	16/8	508-128-03R			Single halyard lead in chromed bronze, including Ø 5.3 mm self-tapping screws and insulating plate. Not to be used for a Code 0 halyard.
12	-	508-734-01	50	57	Double halyard lead fitting in stainless steel. Includes pop rivets. The fitting is to be lacquered inside to insulate it from the mast. This fitting must only be used with rope (not wire halyards). Intended for C137-F212.
14	-	508-735-01	75	85	Double halyard lead fitting in stainless steel. Includes pop rivets. The fitting is to be lacquered inside to insulate it from the mast. This fitting must only be used with rope (not wire halyards). Intended for C227-F286.
12	-	508-847-01	45	50	Single halyard lead fitting in stainless steel. Includes pop rivets. The fitting is to be lacquered inside to insulate it from the mast. This fitting must only be used with rope (not wire halyards). Intended for C137-F212.
14	-	508-848-01	65	72	Single halyard lead fitting in stainless steel. Includes pop rivets. The fitting is to be lacquered inside to insulate it from the mast. This fitting must only be used with rope (not wire halyards). Intended for C227-F286.
14	-	508-839-10	110	125	Double halyard lead fitting in stainless steel. Includes fasteners and insulating washer. This fitting must only be used with rope (not wire halyards). Intended for C304-F305.
14	-	508-839-01	140	157	Double halyard lead fitting in stainless steel. Includes fasteners and insulating washer. This fitting must only be used with rope (not wire halyards). Intended for C321-F324.
16	-	508-837-10	180	200	Double halyard lead fitting in stainless steel. Includes fasteners and insulating washer. This fitting must only be used with rope (not wire halyards). Intended for C365-F370.
16	-	508-837-01	310	340	Double halyard lead fitting in stainless steel. Includes fasteners and insulating washer. This fitting must only be used with rope (not wire halyards). Intended for F406.
14	-	508-930-01	144	163	Single halyard lead fitting in stainless steel. Includes fasteners. The fitting is to be lacquered inside to insulate it from the mast. This fitting must only be used with rope (not wire halyards). Intended for C304-C321, F305-F406.
16	-	508-931-01	218	247	Single halyard lead fitting in stainless steel. Includes fasteners. The fitting is to be lacquered inside to insulate it from the mast. This fitting must only be used with rope (not wire halyards). Intended for C365, F370-F406.

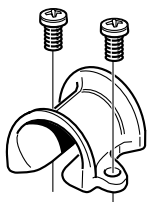

Single halyard lead,
Art. No. 508-159-03R
Art. No. 508-128-03R



Double halyard lead,
Art. No. 508-734-01



Double halyard lead,
Art. No. 508-735-01

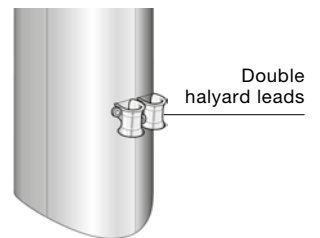

Single halyard lead,
Art. No. 508-847-01



Single halyard lead,
Art. No. 508-848-01.
508-930-01
508-931-01



Double halyard lead,
Art. No. 508-837-01/-10

Quick sail handling with barber haulers for the halyards

Being able to change the spinnaker set from fractional to masthead in a few seconds can be crucial for the racing sailor. Seldén has developed a system of barber haulers to achieve this. When tightened, the spinnaker has a fractional set. When released, the spinnaker reverts to masthead set.

The halyards run through barber hauler rings and are used for spinnakers and jibs, enabling just two halyards to achieve four functions. What foredeck crew would not appreciate having fewer lines to deal with?

The barber haulers are smaller diameter than the halyards, which saves weight aloft.



Masthead hoist



Fractional hoist

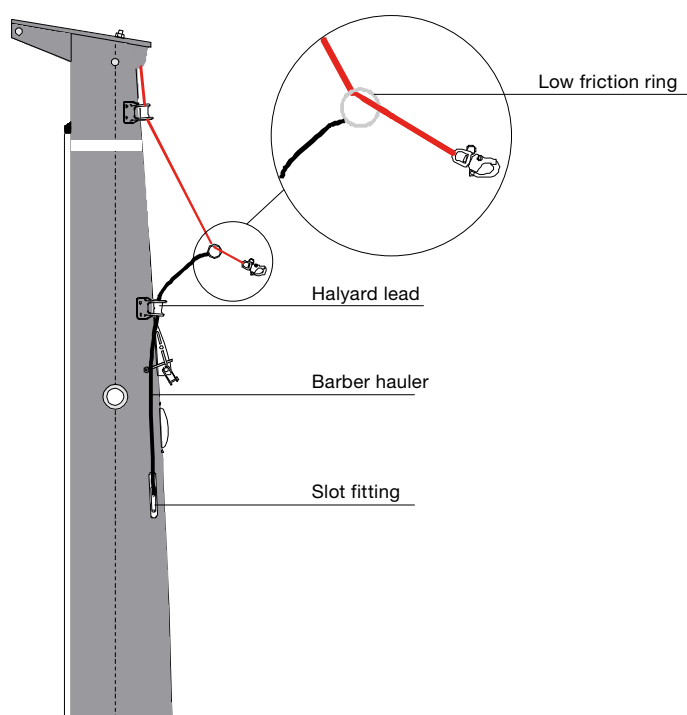



Running backstay attachments

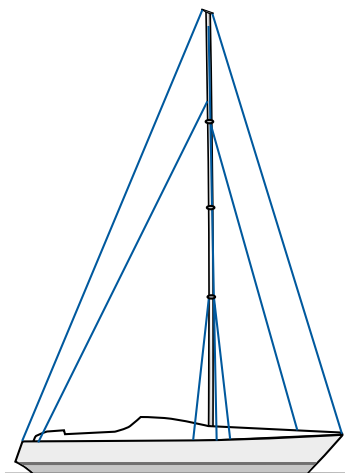

Adding a cutter stay to a masthead rig

Running backstays may be necessary if a cutter stay for a storm jib or staysail is fitted.

Option 1:

The cutter stay is located 3-6% of the height of the foretriangle below the existing forestay. In this case, running backstays are not required to tension the cutter stay.

Option 2:

The cutter stay is located more than 6% of the height of the foretriangle below the existing forestay. In this case, running backstays are necessary. The forestay fitting should be fitted within 1000 mm of the spreaders, with the running backstays preferably 300-500 mm above. Whichever option is chosen, the amount of material cut out from the mast may be over-concentrated in a small area. Please contact Seldén Mast for advice on the correct fastenings and the correct location of the fastenings, as well as the halyard control system.

Conventional fittings for running backstay

Mast section	Art. No. Wire dia., 8/10 mm pin dia., 14 mm
C245	518-031-32
C264	518-031-33
C285	518-031-34
C304	518-031-35
C321	518-031-14
C365	518-031-13
F246	518-031-26
F265	518-031-29
F286	518-031-27
F305	518-031-27
F324	518-031-12
F376	518-031-11
R260	518-031-05
R290	518-031-07



Conventional tang.

Backing plate including securing strap

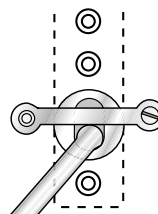

T-terminal backing plate + strap.

Wire dia., mm	Art. No.	Mast profile
3	507-553-02	All
4	507-551-02	
5	507-552-02	
6	507-600-02	
7	507-601-02	
8	507-582-02	
10	507-583-12	C245
10	507-583-13	C264
10	507-583-15	C285 - C365 F246 - F370

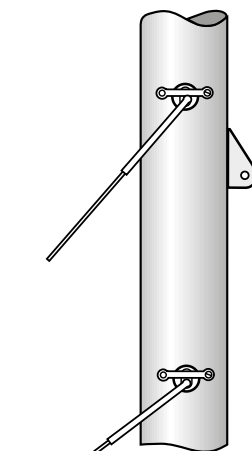

Running backstay and checkstay.

T/Eye toggle for rope runners

Wire dia., mm	Art. No.
3	174-136
4	174-137
5	174-138
6	174-139
7	174-140
8	174-141



When replacing traditional wire runners with lightweight runners, in for example Dyneema, keep your existing backing plate and add a T/Eye toggle.

Spreaders



Seldén T-spreaders for C-sections and F-sections.

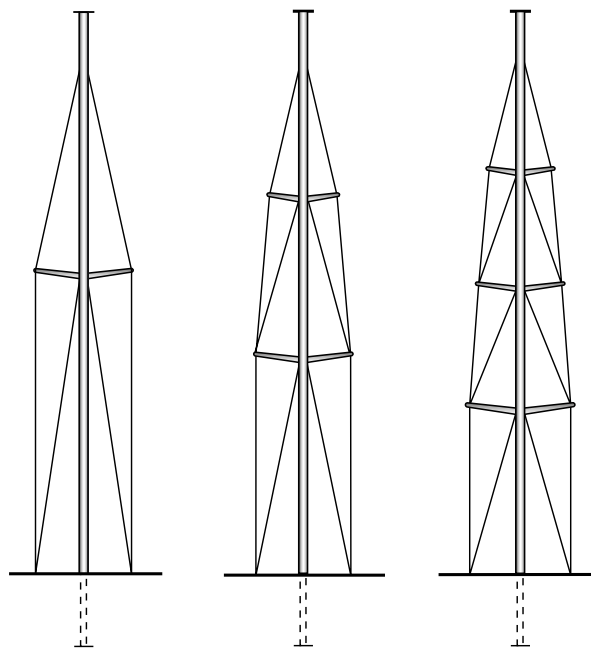

Single spreaders.

Double spreaders.

Triple spreaders.

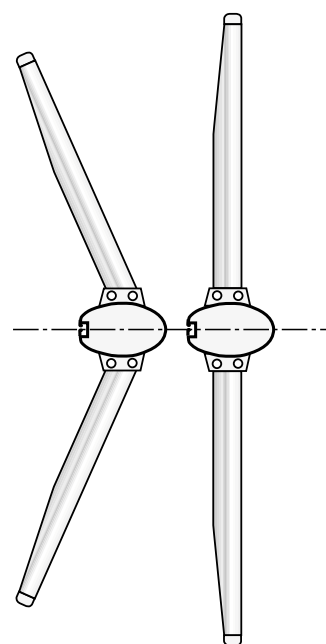

Swept.

In-line.



The C-section's and F-section's spreader fitting is a through-mast design which provides strength as well as a smooth and elegant appearance. The shroud fittings for the lower or middle shrouds are integrated into the spreader attachment. This reduces the number of fittings on the mast, and keeps weight down.

Spreader ends



The design of the spreader ends varies with rig type, the number of spreaders, and whether the lateral rigging is linked or continuous.

Spreader end for linked lateral rigging on 30-70 ft yachts

- Minimal distance from shroud to edge of spreader end. Makes for improved jib trim. Jib can be sheeted close to shroud.
- Large, smooth surface. Gentle on the sail. No tape required.
- No split pins to catch sails or halyards.
- Works with both wire and rod rigging featuring stemball terminals.
- Few parts. Easy to assemble.
- Vertical and diagonal loads well balanced in spreader end. Makes for less stress throughout spreader assembly.
- Lighter than tip-cup versions and most other comparable spreader ends.
- Cast stainless steel, AISI316.

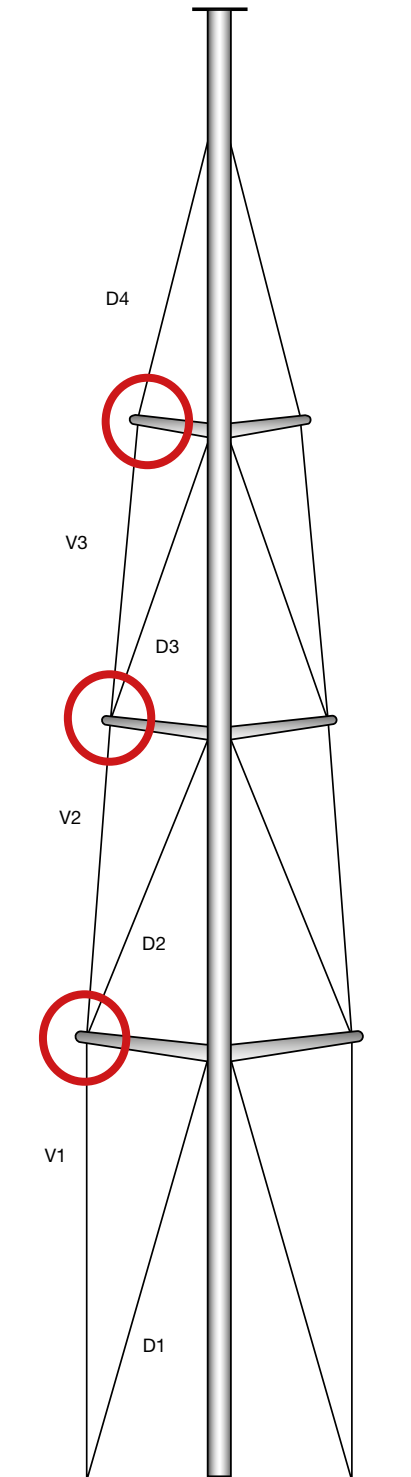

How to order new spreaders



The easiest way to order new spreaders for your mast is to provide one of our dealers with the mast ID-number engraved in to the lower end of the mast section. If this ID-number is inaccessible, the following procedure will do.

- What mast section is it for? Measure the mast longitudinal and athwartships (mm) and compare with sections listed at page 10. For masts produced earlier than 2002 (E, D, R and P sections), see Version 6 of our catalogue, www.seldenmast.com.
- What spreader fitting? You will find a part number on the fitting.
- What length? Measure the length of the front edge of the spreader from inner end to outer end, excluding the end plug (L).
- Starboard or port spreader? We recommend you to order a complete pair as this will ensure that both spreaders have the same angle.
- For a multi spreader rig, what spreader do you need (lower, intermediate or upper)?
- What angle? Provide us with L and S and we will calculate the angle.

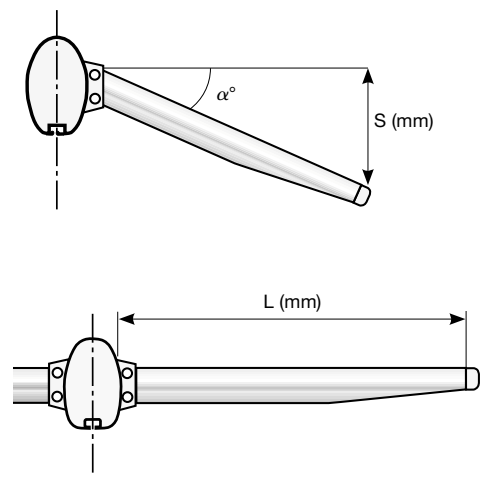

Spreader brackets and spreader assemblies

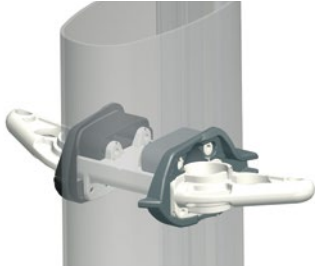

Spreader brackets,
C156-C193, F176-F212.



Spreader brackets,
C211-C304, F212-F305.

Mast section	Bracket pair starboard and port	Spreader width, mm	Length, mm (taper)	Spreader Assembly Art. No. (1 pair) incl. Clevispins, excl. End plugs	Clamping end plug (1 pc)
C137	522-224-01	T-74	400 (400)	503-667-01	Wire ø 5
C153	522-226-01		450	503-668-01	500-650-01
			500	503-669-01	
			550	503-670-01	Wire ø 7
			600	503-671-01	500-651-01
			650	503-672-01	
			700 (500)	503-673-01	
			750	503-674-01	
			800	503-675-01	
			850	503-676-01	
			900	503-677-01	
			950 (750)	503-678-01	
			1000	503-679-01	
			1050	503-680-01	
			1100	503-681-01	
			1150	503-682-01	
			1200	503-683-01	
			1250 (1150)	503-684-01	
			1300	503-685-01	
			1350	503-686-01	
			1400	503-687-01	
			1450	503-688-01	
			1500	503-689-01	
C156	522-108-01	T-90	600 (550)	503-242-01/-11	Wire ø 4-5
C175	522-109-01		650	503-243-01/-11	500-636-01
C193	522-110-01		700	503-244-01/-11	
C211	522-216-01		750	503-245-01/-11	Wire ø 6-8
C227	522-217-01		800 (700)	503-246-01/-11	500-640-01
C245	522-218-01		850	503-247-01/-11	
F176	522-255-01		900	503-248-01/-11	Wire ø10
F194	522-255-02		950	503-249-01/-11	500-820-01
F212	522-255-03		1000 (900)	503-250-01/-11	
F228	522-255-04		1050	503-251-01/-11	
F246	522-255-05		1100	503-252-01/-11	
			1150	503-253-01/-11	
			1200	503-254-01/-11	
			1300 (1000)	503-255-01/-11	
			1600 (1200)	503-256-01/-11	
			1750	503-257-01/-11	

Mast section	Bracket pair starboard and port	Spreader width, mm	Length, mm (taper)	Spreader Assembly Art. No. (1 pair) incl. Clevispins, excl. End plugs	Clamping end plug (1 pc)
C211	522-116-11	T-105	600 (450)	503-341-01/-02/-11	Wire ø 6
C227	522-116-13		650 (600)	503-342-01/-02/-11	500-589-01
C245	522-116-15		700	503-343-01/-02/-11	
C264	522-116-21		750	503-344-01/-02/-11	Wire ø 7-8
C285	522-116-23		800	503-345-01/-02/-11	500-590-01
C304	522-116-25		850 (750)	503-346-01/-02/-11	
F212	522-253-01		900	503-347-01/-02/-11	Wire ø 10
F228	522-253-02		950	503-348-01/-02/-11	500-591-01
F246	522-253-03		1000	503-349-01/-02/-11	
F265	522-253-04		1050	503-350-01/-02/-11	Wire ø 12
F286	522-253-05		1100	503-351-01/-02/-11	500-821-01
F305	522-253-06		1150 (1000)	503-352-01/-02/-11	
			1200	503-353-01/-02/-11	
			1300	503-354-01/-02/-11	
			1400	503-355-01/-02/-11	
			1500	503-356-01/-02/-11	
			1600	503-357-01/-02/-11	
			1750 (1200)	503-358-01/-02/-11	
			1850 (1400)	503-359-01/-02/-11	
			2100	503-360-01/-02/-11	
C264	522-122-11	T-131	600 (550)	503-460-01/-02/-11	Wire ø 6-7
C285	522-122-13		650 (600)	503-461-01/-02/-11	500-700-01
C304	522-122-15		700	503-462-01/-02/-11	
C321	522-122-31		750	503-463-01/-02/-11	Wire ø 8-10
C365	522-122-33		800	503-464-01/-02/-11	500-701-01
F265	522-257-01		850 (800)	503-465-01/-02/-11	
F286	522-257-02		900	503-466-01/-02/-11	Wire ø 12
F305	522-257-03		950	503-467-01/-02/-11	500-702-01
F324	522-257-04		1000	503-468-01/-02/-11	
F370	522-257-05		1050	503-469-01/-02/-11	Wire ø 14
F406	522-257-06		1100	503-470-01/-02/-11	500-703-01
			1150 (1100)	503-471-01/-02/-11	
			1200	503-472-01/-02/-11	
			1250	503-473-01/-02/-11	
			1300	503-474-01/-02/-11	
			1350	503-475-01/-02/-11	
			1400	503-476-01/-02/-11	
			1450	503-477-01/-02/-11	
			1500	503-478-01/-02/-11	
			1600	503-480-01/-02/-11	
			2100	503-481-01/-02/-11	
			2500	503-482-01/-02/-11	

* Compression bar to be used only if diagonal shroud is attached via fitting in mast wall (as opposed to attachment in spreader bracket).

-01 = With cut-out for stemball
-02 = Without cut-out for stemball
-11 = T-spreaders for F-section

Spreader end plugs, linked rig

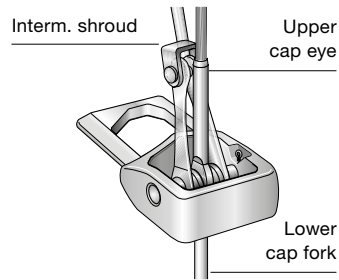

Linked end plug (prior to 2008).



Linked end plug for stemball terminals (from 2008).

Spreader width, mm dia., mm	Upper cap eye dia., mm	Lower cap eye dia., mm	Intern. shroud		Art. No. Prior to 2008	Remarks	Linked end plug for stemball terminals
			Rigging screw dimension	Wire dia., mm			
T-74	7	7	3/8"	5			500-992-01
							Seat radius R11
T-90	5	5	1/4"	3-4	500-637-10		500-998-01
	5	5	5/16"	4-5	500-637-04		
	5	6	1/4"	3-4	500-637-12		
	5	6	5/16"	4-5	500-637-06		
	6-7	6-7	1/4"	3-4	500-637-11	Fork ø6: Use 308-417 (ø12,5 mm hole)	
	6-7	6-7	5/16"	4-5	500-637-05	Fork ø6: Use 308-417 (ø12,5 mm hole)	
	6-7	6-7	3/8"	5-6	500-637-01	Fork ø6: Use 308-417 (ø12,5 mm hole)	
	7	8	5/16"	4-5	500-637-07		
	7	8	3/8"	5-6	500-637-08		
	7	8	7/16"	6-7	500-637-02		500-998-10
	8	8-10	3/8", 5/16"	5-6	500-637-09		
	8	8-10	7/16"	6-7	500-637-03		
T-105	7	7	5/16", 3/8"	5-6	500-555-09		500-998-10
	7	8	5/16", 3/8"	5-6	500-555-05		Seat radius R14/R14/R11
	7	8	7/16"	6-7	500-555-01		
	8	8	3/8", 7/16"	5-7	500-555-04		
	8-10	10	3/8", 7/16"	5-7	500-555-08		
	8-10	10	1/2"	7-8	500-555-02		
	10	12	7/16"	6-7	500-555-07		
	10	12	1/2"	7-8	500-555-03		
	12	12	5/8"	7-10	500-555-06		500-996-01
							Seat radius R18/R18/R11
T-131	8	8	3/8", 7/16"	5-7	500-704-13		500-996-10
	8-10	10	3/8", 7/16"	5-7	500-704-10	Fork ø10: Drill ø12,5 mm hole	Seat radius R18/R18/R11
	8-10	10	1/2"	7-8	500-704-01	Fork ø10: Drill ø12,5 mm hole	
	8-10	12	7/16", 1/2"	7-8	500-704-02		
	8-10	12	5/8"	8-10	500-704-12		
	12	12	1/2"	7-8	500-704-06		
	12	12-14	5/8"	8-10	500-704-05		
	12	14	1/2"	7-8	500-704-07		
	12	14	3/4"	10-12	500-704-03		
	14	14	5/8"	8-10	500-704-14		500-994-01
	14	14	3/4"	10-12	500-704-08		Seat radius R22/R22/R14
	14	16	5/8"	8-12	500-817-01		

Stemball terminals for spreader brackets

Stemball terminals

The lower shrouds and intermediate shrouds hanging in the spreader brackets have a stemball terminal at the upper end. This terminal is located in the cup of the spreader bracket. If required, it can be used with one or two separate cups to bring it up to the correct size for the cup. Measure the width of the complete assembly, including any cups, to ensure that all the cups are in position.



Mast section	Spreader width, mm	Total width of stemball incl. any cups, mm	Wire diameter, mm						
			Art. No. Ø 4 mm	Art. No. Ø 5 mm	Art. No. Ø 6 mm	Art. No. Ø 7 mm	Art. No. Ø 8 mm	Art. No. Ø 10 mm	Art. No. Ø 12 mm
C137 C153	T-74	27.6	308-558-01	308-552-01	308-553-01	308-554-01	308-555	308-556	-
C156 C175	T-90		(T+C+C)	(T+C+C)	(T+C)	(T+C)	(T)	(T)	
C193 C211	T-105								
C227 C245									
C264 C285	T-131	35.6	-	-	308-553-02	308-554-02	308-555-02	308-556-02	308-557
C304					(T+C+C)	(T+C+C)	(T+C)	(T+C)	(T)

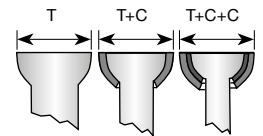

T = Terminal (Stemball)
T+C=Terminal + Cup
T+C+C=Terminal + 2 Cups

Wire diameter, mm	Art. No. Terminal+cups (radius)	Art. No. Terminal (radius)	Art. No. Cups (inner/outer radius)	Art. No. Cups (inner/outer radius)
3	308-550-03 (R9)	308-550 (R6)	306-594 (R6/9)	-
	308-550-04 (R11)			306-572 (R9/11)
4	308-558 (R9)	308-558 (R9)	-	-
	308-558-04 (R11)		306-572 (R9/11)	-
	308-558-01 (R14)			306-573 (R11/14)
5	308-552 (R9)	308-552 (R9)	-	-
	308-552-04 (R11)		306-572 (R9/11)	-
	308-552-01 (R14)			306-573 (R11/14)
6	308-553 (R11)	308-553 (R11)	-	-
	308-553-01 (R14)		306-573 (R11/14)	-
	308-553-02 (R18)			306-574 (R14/18)
7	308-554 (R11)	308-554 (R11)	-	-
	308-554-01 (R14)		306-573 (R11/14)	-
	308-554-02 (R18)			306-574 (R14/18)
8	308-555 (R14)	308-555 (R14)	-	-
	308-555-02 (R18)		306-574 (R14/18)	-
	308-555-05 (R22)			306-595 (R18/22)
10	308-556 (R14)	308-556 (R14)	-	-
	308-556-02 (R18)		306-574 (R14/18)	-
	308-556-05 (R22)			306-595 (R18/22)
12	308-557 (R18)	308-557 (R18)	-	-
	308-557-05 (R22)		306-595 (R18/22)	-
14	308-559 (R22)	308-559 (R22)	-	-

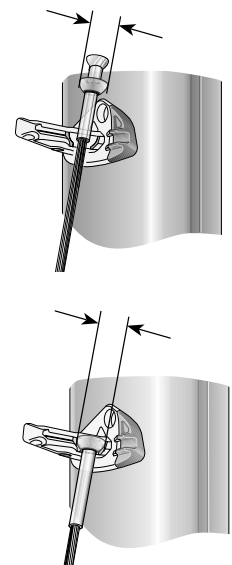

T-spreaders, clevis pins and split pins for spreader brackets

Spreader width, mm	Clevis pin Art. No. (dim., mm)	Split pin Art. No. (dim., mm)
T-74	165-203 (ø10 x 28)	301-049 (ø2,9 x 16)
T-90	165-402 (Ø 12 x 33)	301-049 (Ø 2,9 x 16)
T-105	165-505 (Ø 14 x 41)	301-053 (Ø 3,7 x 20)
T-131	165-552 (Ø 16 x 50)	301-051 (Ø 3,7 x 25)

Full-batten concepts for C-sections

IWS – Inner Wheel Slider (C137 – C153)

The four wheel IWS car simplifies hoisting, reefing and dousing a main sail fitted to our smallest mast sections in the Yacht-range. The car is made of composite making it strong and light



Hanse 315 featuring C153 mast section.

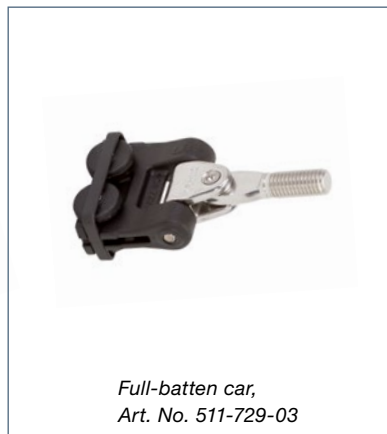
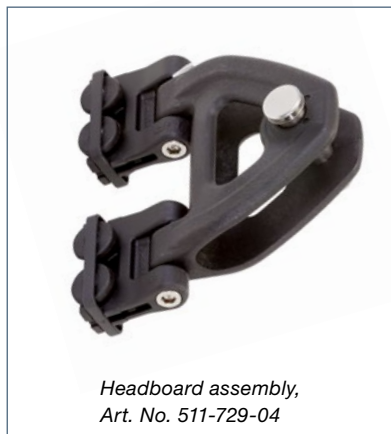

	Mast section	Assembly Art. No.	Max RM kNm at 30° heel				Parts Art. No.	Parts Art. No.
			Monohull		Multihull			
			Mast-head	Fractional	Mast-head	Fractional		
Headboard car	C137, C153	511-729-04	90	70	122	95	511-707-01	166-234-01
Batten car		511-729-03	160	120	215	162	511-712-01	
Sail car		511-729-02	160	120	215	162	511-719	

Sail entry,

C-sections

The sail entry gate is designed for use with our MDS cars or with conventional sail slides. When using it with MDS cars, you simply remove the sail entry gate when installing or removing the cars. When using it with conventional slides, use the spring-loaded mid section of the sail entry gate.



Sail entry gate C156-C304, Art. No. 505-519-01



Sail entry gate easily removed to fit or remove Seldén MDS cars.



Sail entry gate designed for use with Seldén MDS cars or conventional sail slides. For detailed information about our conventional sail slides, please see *Sailmakers Guide*, www.seldenmast.com.

Bolt rope extrusion and sail entry

Sails with bolt rope can be used in our C-sections. A new sail feeder is assembled approximately 700 mm above the boom bracket. The PVC bolt rope extrusion is fed into the standard luff groove.



Mast section	Bolt rope extrusion Art. No. and length	Sail entry Art. No.
C156-C304	535-710 (6000 mm)	505-526-01

The MDS full-batten concept for C-sections



See Seldén MDS in action.

Full support in all directions

As the name implies, Seldén's MDS (Multi-Directional Support) cars are supported in all directions, making sail handling simpler. A full batten always creates a side load on the cars, particularly when you release the halyard for taking a reef. Each car has side-load absorbing wheels that run against the guiding flanges in the luff groove. The interaction between the mast section and the MDS car deals with longitudinal loads, as well as side loads. This is the essence of the MDS concept. Since the cars need no external track, there is also less weight aloft.

The MDS cars are easy to keep clean and are easy to install or remove from the luff groove.

The MDS system is a suitable complement to the Seldén Single Line Reef boom. With such a combination on board, you have a simple and easily manoeuvred system for handling the mainsail in all weathers.

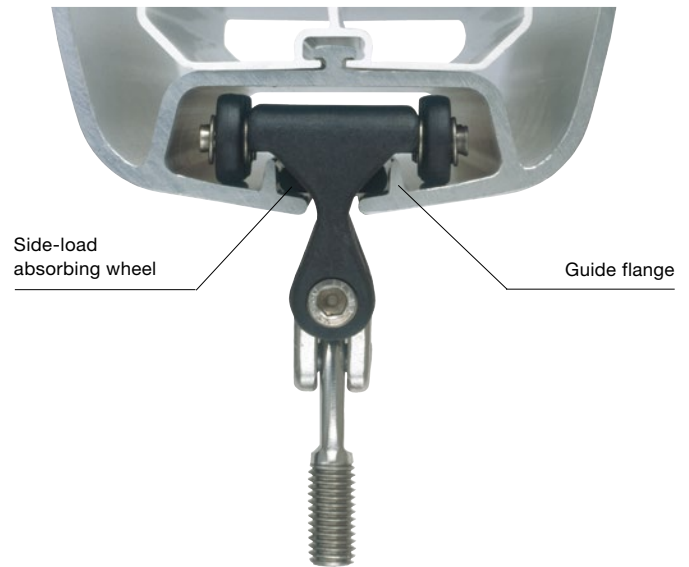

Side-load absorbing wheel

Guide flange

- 1) Breaking load 4 kN.
- 2) Breaking load 6 kN.
- 3) Breaking load 9 kN.
- 4) Breaking load 13.5 kN.
- 5) Breaking load 25 kN.
- 6) Measurement see: Fig 1.

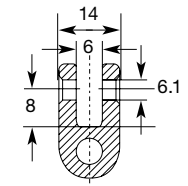

Fig 1.
Art. No. 511-723.

Parts and RM-limits

Mast section	Assembly Art. No.	Max RM kNm				Parts Art. No.	Parts Art. No.	
		Monohull Mast-head	Fractional	Multihull Mast-head	Fractional			
Head-board	C156, C175 C193, C211 C227, C245	511-707-01	90	70	122	95	511-707	166-234-01
	C264 C285 C304	511-708-01	160	120	215	162	511-708	
	C321 C365	511-728-01	250	200	335	270	511-728	165-504-01
Head-board car	C156 C175 C193	511-702-04 ¹⁾	55	40	75	54	511-707-01	511-702-02
	C211 C227 C245	511-701-04 ²⁾	90	70	122	95		511-701-02
	C211, C227 C245, C264 C285, C304	511-701-06 ³⁾ 511-717-06 (MDS 68 ALU)	160 330	120 250	215 440	162 330	511-708-01	
	C321 C365	511-730-06 ⁴⁾ (MDS 80) 511-731-06 ⁵⁾ (MDS 80HD)	250 550	200 450	335 750	270 600	511-728-01	511-730-02 (MDS 80) 511-731-02 (MDS 80HD)

MDS 45



Headboard assembly,
Art. No. 511-702-04



Full-batten car,
Art. No. 511-702-03



Intermediate sail car,
Art. No. 511-702-02
Incl. bushing for webbing,
Art. No. 511-719

MDS 68/68ALU



Headboard assembly,
Art. No. 511-701-04
Art. No. 511-717-06 (ALU)



Full-batten car,
Art. No. 511-701-03
Art. No. 511-717-03 (ALU)



Intermediate sail car,
Art. No. 511-701-02
Art. No. 511-717-02 (ALU)
Incl. bushing for webbing,
Art. No. 511-719

MDS 80/80HD



















Headboard assembly,
Art. No. 511-730-06
Art. No. 511-731-06 (HD)



Full-batten car,
Art. No. 511-730-03/511-730-09
Art. No. 511-731-03/
511-731-09 (HD)



Intermediate sail car,
Art. No. 511-730-02
Art. No. 511-731-02 (HD)

Mast section		Assembly Art. No.	Max RM kNm				Parts Art. No.	Parts Art. No.
			Monohull		Multihull			
			Mast-head	Fractional	Mast-head	Fractional		
Batten car	C156 C175 C193	511-702-03	90	70	122	95	511-702-02	511-712-01 (M10)
								
	511-702-08						511-723 ⁶⁾	
C211, C227 C245, C264 C285, C304	511-701-03 511-717-03 (MDS 68ALU)		160 450	120 335	215 600	162 470	511-701-02 (MDS 45)	511-712-01 (M10)
		511-701-08 (MDS 68) 511-717-08 (MDS 68ALU)						511-723 ⁶⁾
								
C321 C365	511-730-03 (M10) (MDS 80) 511-730-09 (M12) (MDS 80) 511-731-03 (M10) (MDS 80HD) 511-731-09 (M12) (MDS 80HD)		250 550	200 450	335 750	270 600	511-730-02 511-731-02 (MDS 80HD)	511-727-02 (M10) 511-727-01 (M12)
								
Sail car	C156, C175, C193 C211, C227, C245 C264, C285, C304	511-702-02	90	70	122	95	511-702-01 (MDS 45)	153-118
								511-719
	C211, C227 C245, C264 C285, C304	511-701-02 ²⁾ (MDS 68) 511-717-02 (MDS 68ALU)		160 450	120 335	216 660	162 470	511-701-01 (MDS 68) 511-717-01 (MDS 68ALU)
							511-719	
C321 C365	511-730-01 (MDS 80) 511-731-01 (MDS 80HD)		250 550	200 450	335 750	270 600	511-730-01 (MDS 80) 511-731-01 (MDS 80HD)	153-139
								

RCB, full-batten system

For retro-fitting on E-sections and D-sections

The Seldén RCB (Round Circulating Ballbearings) full-batten system facilitates full-batten sail management, and makes it much easier to set and reef the mainsail. The system is based on linear ball races and recirculating balls. The cars run with hardly any friction at all, even under the high compression loads produced by full-length battens.

The track and cars are made from aluminium which, together with Torlon ball bearings, makes the system strong and durable.

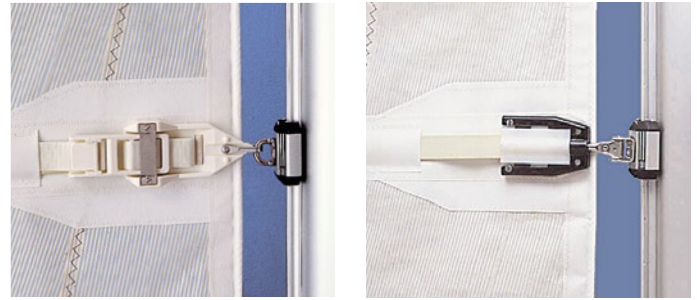

RCB batten car with eye.

RCB batten car with M10 bolt.

Universal

The attachment can be used in conjunction with most batten fittings. It provides the full freedom of movement so essential for easy operation and long life.

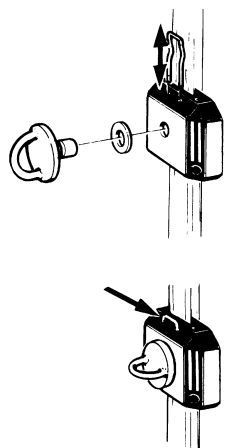
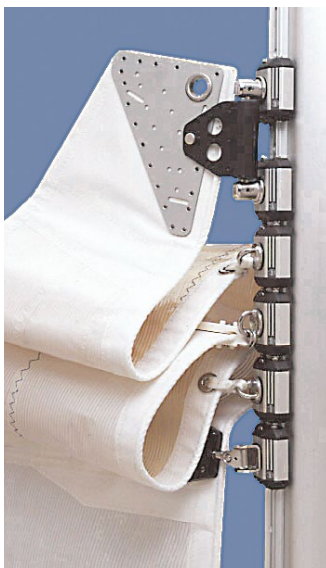

Locking fork, Art. No. 511-591.
Plastic washer, Art. No. 164-039.

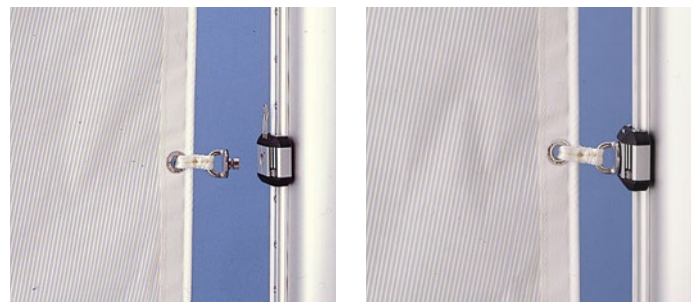

Easy to fit.

Practical

The swivel fitting can easily be removed from the car – an advantage when the sail is to be fitted or removed from the mast. It can also be sent separately to the sailmaker for fitting to the sail.

High performance lubrication



Lubrication for Torlon® ball bearings, Art. No. 312-534.
One drop will do!

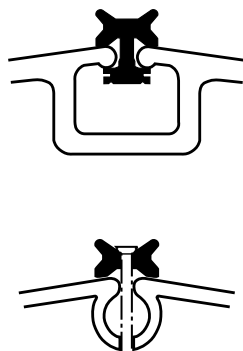

Easy to fit

The RCB track, which comes complete with screws and special nuts, is easy to fit on a Seldén mast. Just push the track into the original mast groove and tighten up. The attachment system is tailored to Seldén masts, but it will also fit those with a similar luff gap (approx. 6 mm or 1/4"). Other masts can be fitted with the track by screwing it directly in place.

For Isomat, see remarks on next page.

Description		Reference	Dim., mm
Headboard toggle*		A	Min. 59
		C	96
		D	40
Batten fittings	Rutgerson: No 1490 (eye)	B	56
	No 1580/No 1590 (M10)	B	56
	Aquabatten: SDA-A 41219	B	73
	A453 (M10)		
Cars		H	26
	Length over all, mm	L	72.5

* Clevis pin = Ø 10 mm Hole in head board toggle = Ø 12 mm

Standard		
Righting moment at 30° heel	Masthead	70 kNm
	Fractional	50 kNm
Approx. displacement	Masthead	12-14 tonnes
	Fractional	8-10 tonnes
Heavy duty		
Righting moment at 30° heel	Masthead	120 kNm
	Fractional	90 kNm
Approx. displacement	Masthead	20-24 tonnes
	Fractional	15-18 tonnes



Black anodised RCB car with lightening holes. Used for carbon masts. Art. No. 511-703-11.

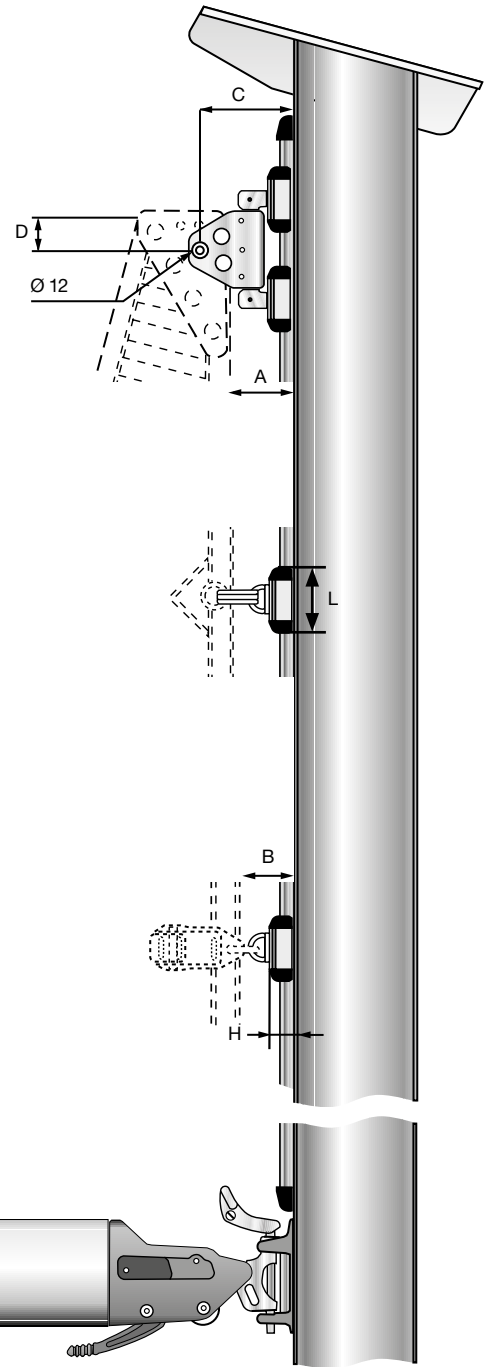

	Description	Art. No.	Remarks
Track	Complete extrusion set including connection pieces and fastenings. L = 12850 mm**	515-525-12	* Fasteners for Isomat/Sparcraft masts NG60, NG70, NG80, NG86, NG105 (sail groove slot 14 mm) Fasteners for extrusion set (L = 12850 mm): Art. No. 515-561-10 Fasteners for extra extrusion (L = 2300 mm): Art. No. 515-561-01 Additional set of fasteners for heavy duty application (L = 2300 mm): Art. No. 515-561-03
	Extrusion set excluding connection pieces and fastenings. L = 12850 mm*	515-525-22	
	Extra extrusion length including connection piece and fastenings. L = 2300 mm**	515-525-11	
	Extra extrusion length excluding connection piece and fastenings. L = 2300 mm*	515-523-02	
Cars	Headboard cars without toggle	2 x 511-581-11	** Fasteners for Isomat/Sparcraft masts 1-260 and 1-330 (sail groove slot 5 mm). Fasteners for Seldén masts can be used. *** For carbon masts.
	Car without eye	511-581-11	
	Black anodised car with lightening holes, excl. eye/M10 bolt***	511-703-11	
Fittings	Headboard toggle	511-595-11	
	M10 bolt	511-598-01	
	Eye (Sailcar)	511-590-01	
	Extra set of fastenings for 2300 mm heavy duty extrusion.	515-535-03	



Keel-stepped and deck-stepped masts,

C-sections and F-sections

The T-base and deck ring systems are made to fit both Seldén's conventional mast sections and their matching furling sections. They are also made to create deck order among halyards. The blocks are fastened to the T-base or deck ring with a removable stainless steel shaft, which makes it easy to rearrange the blocks. The deck ring incorporates a state-of-the-art mast wedging system.

Eyes for halyard stowage



*T-base for deck-stepped masts with integrated block fastenings.
Just remove stainless steel shaft to fit up to eight blocks.
A two-piece shaft is available for narrow deck layouts.*

Keel-stepped masts,

C-sections and F-sections

For hydraulic mast-jack systems, see page 120.

The deck ring system for keel-stepped masts has a multi-purpose design. The forward composite wedge with rubber chocking is removed while bringing the mast through the deck ring. When refitted and tightened it slides down/aft and secures the mast.

The tie rod has four fixed settings, each with plenty of leeway for adjustment.

The T-base for keel-stepped masts can be adjusted longitudinally (fore-and-aft) with the mast still in place. Just ease off the rigging and turn the adjusting screw of the T-base until the required prebend and rake are achieved.

The underside of the heel plug is convex, in order to allow rake without subjecting the mast section to point loading.



Remove the wedge.



Step the mast and replace the wedge.



Secure the mast by tightening the nut on the wedge.



Block stand-up, rubber.



Adjustable T-base. Adjusts easily with mast still in place.



Convex underside of heel plug – distributes compression load evenly on the mast section.

Deck ring system

Mast section	Deck ring, incl. 4 halyard attachments + axle for integrated blocks*, (dim., mm)	Separate block-axle	Separate 2-piece block axle	Locking screw for block axle	Block stand-up rubber	Wedge	Shaped rubber wedges	
							Fore 1 off	Aft 2 off
C153, C156	533-030-01 (275 x 240)	166-274	-	155-624	319-512	530-208	530-209	530-221
C175, F176	533-029-01 (316 x 242)	166-270	-				530-210	530-213
C193, F194					319-669	530-209	530-209	530-212
C211, F212	533-022-01 (349 x 300)	166-221	166-260-01				530-210	530-213
C227, F228					319-680	530-211	530-209	530-212
C245, F246	533-023-01 (401 x 344)	166-224	166-261-01				530-210	530-213
C264, F265				155-609	530-214	530-214	530-210	530-213
C285, F286	533-024-01 (450 x 372)						530-209	530-212
C304, F305					530-218	530-218	530-210	530-212
C321, F324	533-039-01 (520 x 382)	166-295	n/a	153-014			530-241	530-242 (1 pc)
C365, F370	533-038-01 (573 x 410)	166-229	n/a		530-216	C365 530-245 F370 530-241		
F406	533-036-01 (603 x 403)	n/a	n/a	n/a	n/a	n/a	530-575	530-575

* Blocks are not included.



Deck ring with moulded mast coat.

Tie rods with four fixed settings – plenty of leeway for adjustment.



Mast coats (moulded), C-sections and F-sections
C-sections and F-sections

Mast section	Mast coats Art. No.	Hose clips, Art. No.	
		Upper	Lower
C153, C156	530-053	312-201	312-204
C175, F176	530-054	312-202	312-205
C193, F194	530-055	312-203	312-206
C211, F212	530-056	312-204	312-206
C227, F228			
C245, F246	530-058		312-206
C264, F265		312-205	
C285, F286	530-060		2 x 312-203
C304, F305		312-207	
F324	530-038 + 530-040 (canvas)	-	2 x 312-205

Replacement coats,
Can be fitted with the mast stepped.

Section	Repl. coat	Section	Repl. coat
C153, C156	530-053-51	C245, F246	530-058-51
C175, F176	530-054-51	C264, F265	530-058-51
C193, F194	530-055-51	C285, F286	530-060-51
C211, F212	530-056-51	C304, F305	530-060-51
C227, F228	530-056-51		

Tie-rod fittings	Tie-rod		T-base	
	Cover	Adjustable	Fixed	
508-259-01	508-260	510-152-01	-	
		C153= 510-237-01		
		510-134-01	510-136	
508-259-03	-	510-143-01	510-141	
		510-125-02	-	
Tie rod fitted to keelson	-	510-190-01	-	



Deck-stepped masts,

C-sections and F-sections



Stainless rail,
Art. No. 508-728 and
508-179



Block stand-up,
stainless.
Art. No. 308-017.



Block stand-up, rubber.
Art. No. small 319-512 (PBB50)
Art. No. medium 319-669 (PBB60/70)
Art. No. large 319-680 (PBB80)

T-base

Mast section	T-base (dim., mm)	Rail (stainless) for attaching block, (dim., mm)	Plug	Cable hose (Ø 48 mm)	Block stand-up stainless spring
C211, F212 C227, F228 C245, F246	510-136-01 (275 x 125)	-	319-649	319-620-02	308-017
C264, F265 C285, F286 C304, F305	510-141-01 (380 x 160)	508-728 (390 x 180)			
C321, F324 C365, F370	510-125-01 (480 x 180)	508-179 (415 x 190)	-	-	-

T-base with integrated block attachment

Mast section	T-base, including halyard attachment + axle for integrated blocks*, (dim., mm)	Separate block axle	Separate 2-piece block axle	Locking screw for block axle	Block stand-up rubber	Cable hose
C137, C153	510-236-01 (162x141)	166-461	-	319-828	319-512	319-639-01 (Ø42 mm)
C156 C175, F176 C193, F194	510-157-01 (225 x 151)	166-272	-	155-807	319-512	319-639-01 (Ø42 mm)
C211, F212 C227, F228 C245, F246	510-135-01	166-221	166-260-01	155-624	319-669	319-620-02 (Ø48 mm)
C264, F265 C285, F286 C304, F305	510-142-01 (388 x 264)	166-228	166-262-01	155-613	319-680	

* Blocks are not included.



Convex underside of heel plug – distributes compression load evenly on the mast section.



Small protrusion on top side of heel plug – acts as spacer for cable conduit. Allows cables to run freely.



Cable hose prevents moisture from entering the cabin.

T-base + hose,
Art. No. 510-135-01
+ 319-620-02.



Plugged T-base with built-in block fittings. Cables exit through mast heel for deck connections.



T-base, Art. No. 510-136-01.

Cables can be led through the cable hose and further down in the compression post. They may also exit straight through the heel plug for deck connections.



Deck ring system for larger keel-stepped masts

The opening is held by a sturdy O-ring, squeezed vertically between two deck rings. The lower deck ring is permanently bolted to the deck head. When in place, it allows sufficient mast movement in all directions.



Deck rings

Mast section	Art. No.	(dim, mm)	Remarks
C321	533-016-01	(358 x 202)	Rails and tie-rods cannot be integrated.
E365	533-019-01	(405 x 225)	
F324	533-016-01	(358 x 202)	
R370	533-019-01	(405 x 225)	
F406	533-036-01	(583 x 383)	

Mast coats

Mast section	Deck ring size, mm	Inner sealing coat Art. No.	Outer canvas coat Art. No.
C321	358 x 202	530-038	530-040
E365	405 x 225	530-039	530-041
F324	358 x 202	530-038	530-040
R370	405 x 225	530-039	530-041
F406	583 x 383	530-069	-

Winch pads

The Seldén winch pads fit all mast sections and are easy to install. Each winch pad is labelled with instructions for fitting to winch bases. The pads have a 5° angle to prevent override on the winch (reefing winch pads 15°). They are corrosion insulated with plastic insulating sheet and have well-rounded corners to avoid sail chafe. Seldén offers winch pads for halyard winches and reefing winches.

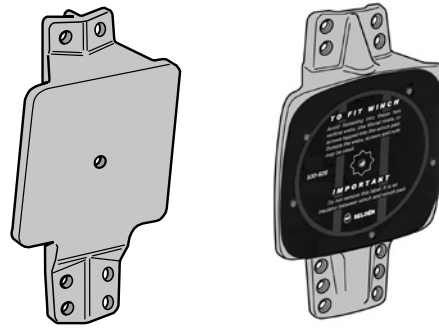

5° Halyard winch pads incl. insulating sheet					15° Reefing winch pads incl. insulating sheet		Stopper pad
Art. No.	523-043-01	523-041-01	523-042-01	523-044-01	-	523-045-01	523-048-01
					523-057-01*	523-056-01*	
Dimension, mm	85 x 85	110 x 110	140 x 140	180 x 180	100 x 100	140 x 140	150 x 106
Safe working load	3 kN	5 kN	10 kN	15 kN	5 kN	10 kN	20 kN
Max. winch							
Andersen		6, 10, 12 ST, 16 ST	28, 28 ST, 40, 40 ST		6, 10, 12 ST, 16	28, 28 ST, 40, 40 ST	
Lewmar		6, 7, 8	16, 26, 30, 30 ST, 40, 40 ST		6, 7, 8	16, 26, 30, 30 ST, 40, 40 ST	
Seldén				R30, R40, R46, R52			

ST = Self tailing

* For C-sections with wider luff-grooves.

Cleats



Art. No. 511-030-01.



Art. No. 511-016-02.



Art. No. 511-015-02.



Art. No. 511-025-02.



Art. No. 511-031-02.

Art. No.	Material	C-C, mm	Length, mm	Fasteners included in kit
511-030-01	Composite	19	100	2 rivets, Ø 4.8
511-016-02	Composite	40	145	2 screws, MRT 6 x 16*
511-015-02	Aluminium	45	165	2 screws, MRT 6 x 16*
511-025-02	Aluminium	53	195	2 screws, MRT 6 x 16*
511-031-02	Composite	45	156	2 screws, MRT 6 x 25*

* Self tapping screws.



Cross beams for catamarans



Non-Slip area on top of the cross beam.



The bridge wire is secured in a slot on top of the bridge support. All prepared for navigational lights.



Fitting for anchor or tender.



Hull brackets can articulate to absorb movements between the hulls and the beam.



Snap-in trampoline sliders



Slider



The cable from the navigational light is fed into the cross beam...



...and in to the cable conduit.



The forestay load is absorbed by a stainless support underneath the cross beam.

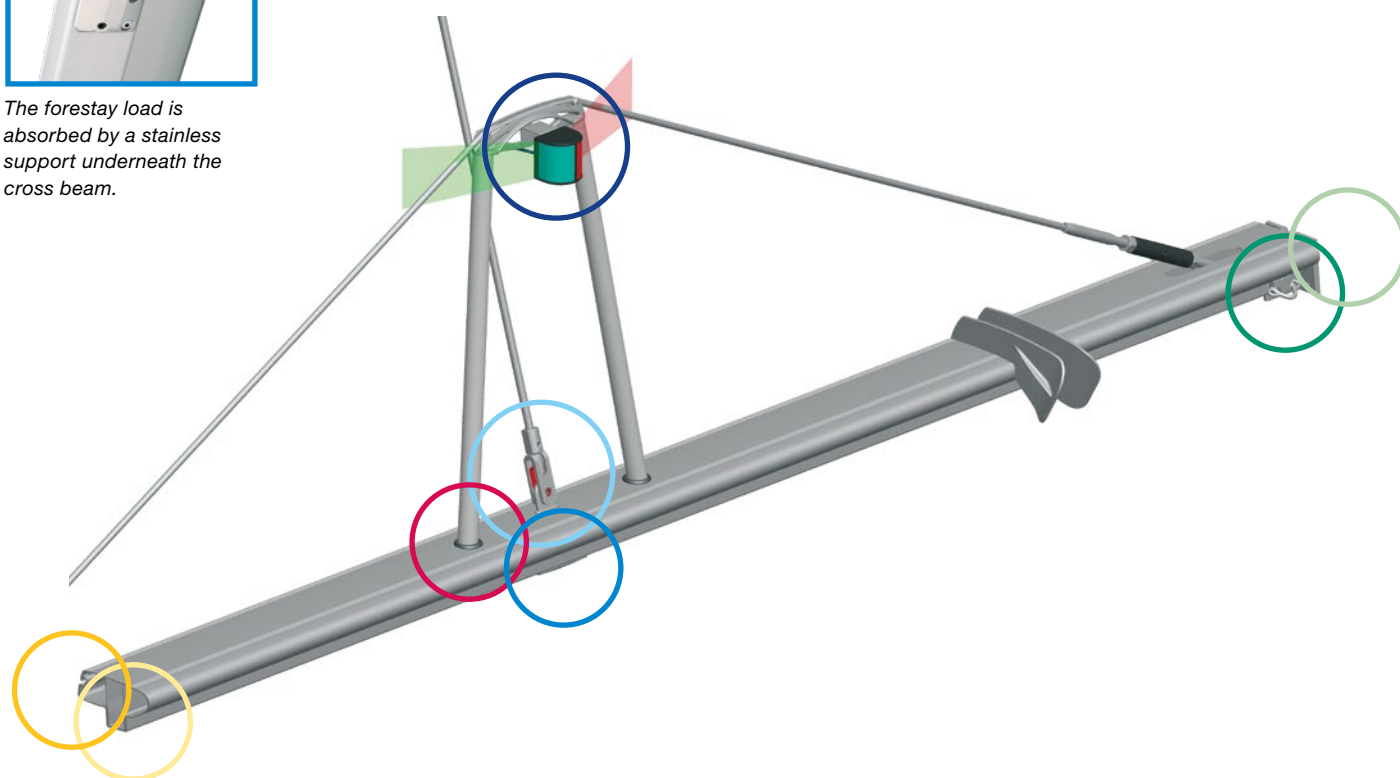

Our cross beams for catamarans are designed to be more than just a structural connection between the hulls. Integrated cable conduits, fittings for navigational lights and a clever attachment for the trampoline are good examples of details appreciated by the boat builders.

Forestay dimension, Ø mm	Forestay fitting, hole diameter, Ø mm	Max length between hulls, mm	Bridle wire, Ø mm	Description of the system
10	16	6400	12	XB240-FS10-6400
12	19	5900	14	XB240-FS12-5900







BOOMS and Rodkickers

Introduction	58
Seldén racing booms	59
Seldén carbon booms	60
Reefing systems	62
Boom sections choice	64
Booms for slab reef, Single Line Reef and furling masts	66
Boom brackets	67
Reef line kits and sliders	70
Rodkicker rigid vang	72
Rodkicker brackets	75

For hydraulic boom vangs,
see page 128.

Booms with a strong profile

Seldén booms have a wealth of sophisticated features and can be equipped with a variety of reefing systems to suit different boats and the needs of different sailors. The booms can be fitted for traditional slab reefing or Single Line Reef, or be used for furling masts. The boom extrusions are relatively deep in relation to their width, allowing a lighter extrusion with high resistance to vertical bending. This makes them perfect for use with modern, stiff sailcloth and efficient Rodkicker rigid vang.

Inboard end

The inboard end fitting contains sheaves for reef lines and outhaul. Spring loaded rope stoppers can be fitted to the inboard end as option. Every stopper is colour-coded to match the relevant line. The clevis pin connecting the inboard end to the boom toggle has a D-shaped head in order to prevent rotation.

A perfect end

The boom end is gently rounded. It is fastened with screws and is open at the back to facilitate maintenance and line replacement. It comes with a cast preventer bracket, a topping lift eye and numbered line compartments.

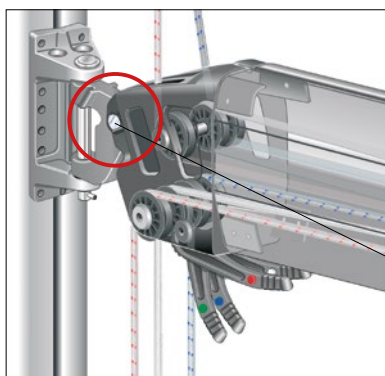

D-shaped head of clevis pin.
See spare parts list for details.

	Boom section	Dim., mm height/widht	I_y cm ⁴	I_x cm ⁴	Wall thickness mm	Weight kg/m	W_y min cm ³	W_x min cm ³	Sail groove mm
	B087	86/60	60.2	27.7	2.0	1.55	13.4	9.3	5.5 ± 0.6
	B104	104/60	97.5	33.6	2.0	1.71	18.5	11.2	5.5 ± 0.6
	B120	120/62	155	42.5	1.8	2.12	24.8	13.7	5.5 ± 0.75
	B135	135/71	265	70	2.0-2.8	2.66	39	19.5	5.8 ± 0.75
	B153	153/86	438	132	2.5-2.9	3.60	55.2	30.8	10 ± 0.75
	B172	171/98	720	219	2.3-3.2	4.66	81.5	44.7	10 ± 0.75
	B199	199/122	1257	407	3.1	5.90	124.6	67.00	10 ± 0.75
	B250	250/140	2706	692	3.2	7.95	200.1	101.3	6.25 ± 0.75
	B290	290/155	5209	1524	4.1	11.50	339	196	10.25 ± 0.75
B380	380/186	12030	3283	4.5-9.0	17.80	586	353	No groove	

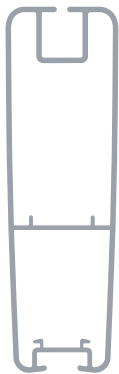

Seldén racing booms

Developed jointly with sailors and designers in the World Match Racing Tour. Deep boom profile for maximum vertical stiffness. This retains sail trim, even at very high kicker and sheet loads.

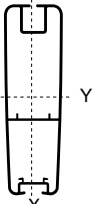
	Boom section	Dim., mm height/width	I_y cm ⁴	I_x cm ⁴	Wall thickness mm	Weight kg/m	$W_{y^{min}}$ cm ³	$W_{x^{min}}$ cm ³	Sail groove mm
	B190	190/60	723	94	2.5-3.5	4.86	74	31	5.5±0.75
	B230	230/70	1399	176	2.7-3.6	6.53	117.8	50.5	6.25±0.75

Light booms in carbon fibre



Seldén supply carbon booms that harmonise with its carbon mast range. Carbon booms offer weight savings of up to 35% compared to aluminium. This means that boom weight on a typical 35 ft boat is reduced from 30 kg to just 20 kg.

A lighter boom makes gybing less dramatic, as the boom has less momentum. This has a positive effect on the whole boat, especially with regard to the service life of the mainsheet attachment.

A lighter boom also reduces the tendency of the boat to roll when sailing downwind and it improves the effect of the Rodkickers' gas spring. The section modulus of a carbon boom is twice as high as that of an aluminium boom with the same weight per meter. A stiff boom makes for improved trim and thus higher boat speed.

Boats that sail IRC, and which are already fitted with a carbon mast, suffer no further rating penalty by up-grading to a carbon boom.



End fittings

In order to reduce weight, while still providing sheaves for single line reefing, we have made the inboard end fitting as short as possible. The outboard end, which is integrated into the carbon section, is finished with a carbon cover plate.

Vang attachment

The carbon booms feature hand laid local reinforcement in the vang attachment area.

Mainsheet attachment

The mainsheet block is attached using a Dyneema® stop that passes through an aramid tube in the boom. Stainless steel bushings at either end of the tube prevent wear, while local carbon reinforcement provides the extra strength required. Booms with “German” split mainsheet systems have fastening positions for blocks at the inboard end, and two webbing straps to hold up the mainsheet.

The Seldén ‘Y’ boom is a Park Avenue type carbon boom designed to allow easier reefing and sail stowage for the larger cruising yacht. Lazy jacks guide the sail on to the top of the boom while the beautifully shaped wings of the ‘Y’ boom help to catch and retain the mainsail when lowered. A sail cover is then zip closed over the top of the sail. Single line reefing and boom lights can be specified as options. ‘Y’ booms can only be supplied with a painted finish.

Reefing options

Carbon booms can be supplied ready for conventional slab or single line reefing. Clutches can be integrated into the inboard end if you do not wish to lead the reef lines to the cockpit.

Outhaul

We offer two outhaul systems. The standard version features a Dyneema® outhaul line for leading back to the cockpit. It is also available as an internal, geared cascade system with an outhaul line leading to the cockpit or to a block and cam cleat mounted on the underside of the inboard end. This cascade system is not available with single line reefing.

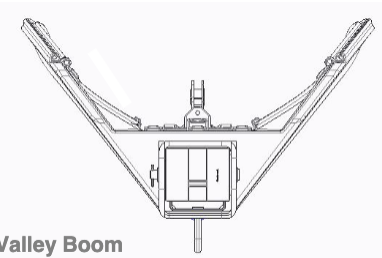
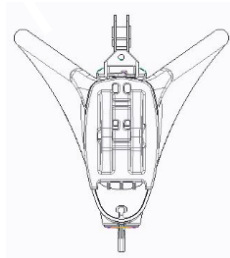

Seldén Valley Boom

Reefing systems

Traditional slab reef

This is a simple and efficient reefing system. The reef cringle on the luff is hooked on to fixed hooks at the inboard end. The leech is reefed down with a line running to a winch at the mast. Stoppers at the inboard end allow the same winch to be used with any line on the boom. Lines not in use are kept clear of the winch by a lineguide. Alternatively, the line can lead aft to a cockpit winch.

The boom can also be equipped for slab reefing with hooks on lines. This system is suitable for larger yachts where it can be difficult to hook the reef cringle to a fixed hook in heavy winds.

S-Hooks for slab reef or Cunningham

Art. No.	Diameter, mm	Ultimate load, N
307-407	6	5000
307-408	8	6500
307-410	10	9500

Instant reefing with Single Line Reef

Single Line Reef is a familiar concept, but made practical and reliable by Seldén. All you do is ease off the halyard to premarked reefing points and then haul in on the reefing line. The luff and the leech are reefed at the same time. A system of guided blocks inside the boom ensures that the lines do not tangle. The system has a 2:1 gear ratio, making reefing fast and simple, without having to leave the cockpit.

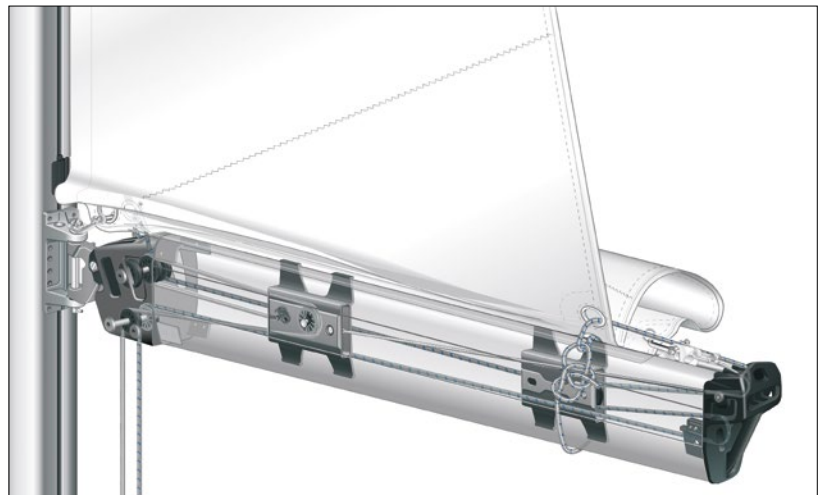

Single Line Reef. Pulls down luff and leech at the same time. Operated from the safety of the cockpit.

Seldén furling mast

When used with a furling mast, the booms are fitted with low friction outhaul cars. The cars are equipped with horizontal and vertical wheels, enabling them to absorb forces from every direction.



Boom fitted with outhaul car for Seldén furling mast.

Single Line Reef



Release the Rodkicker.



Slacken the mainsheet.



Ease off the main halyard to premarked reefing points.



Tension the reef line up to the marked position on the line.



*The reef is in.
Remove any slack in other reefs.*

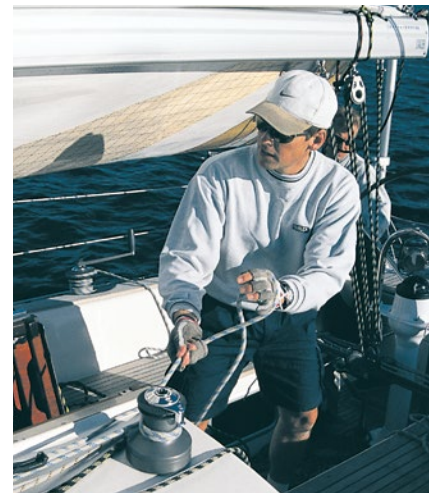

If necessary, apply more main halyard tension.



Adjust the mainsheet.



Adjust the Rodkicker.



It's as simple as that!

Boom sections choice

To select the correct boom section, you will need to know the sail foot length (E) and righting moment (RM). If the RM is not known, displacement is an alternative.

The E and Y measurements must also be known for dimensioning purposes. The length of the boom is sometimes determined by other factors than E and therefore we need the S measurement as well. A good example is when the boom extrusion needs an over-length to allow the main sheet to pass a sprayhood.

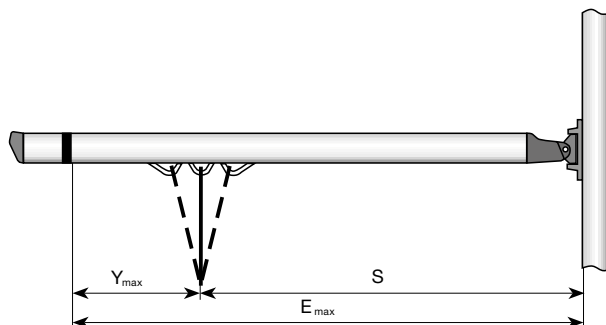

Masthead rigs, E_{max} and Y_{max} (m)

Section	RM 30 kNm	Displ. tonnes	B087		B104		B120		B135		B153		B172		B199		B250		B290		B380		
			E_{max}	Y_{max}	E_{max}	Y_{max}	E_{max}	Y_{max}	E_{max}	Y_{max}	E_{max}	Y_{max}	E_{max}	Y_{max}	E_{max}	Y_{max}	E_{max}	Y_{max}	E_{max}	Y_{max}	E_{max}	Y_{max}	
6	1.2		3.3	1.7	4.0	1.8	4.2	2.1															
8	1.6		3.3	1.4	4.0	1.6	4.2	1.8	4.6	2.5													
10	2.0		3.3	1.3	4.0	1.4	4.2	1.6	4.6	2.2													
12	2.4		2.9	1.2	4.0	1.3	4.2	1.5	4.6	2.0	5.1	3.1											
14	2.8		2.6	1.1	3.5	1.2	4.2	1.4	4.6	1.9	5.1	2.8											
16	3.2				3.2	1.1	4.2	1.3	4.6	1.8	5.1	2.7	6.1	3.7									
18	3.6				3.0	1.1	4.1	1.2	4.6	1.7	5.1	2.5	6.1	3.5									
20	4.0				2.8	1.0	3.8	1.1	4.6	1.6	5.1	2.4	6.1	3.3									
25	5.0				2.4	0.9	3.3	1.0	4.6	1.4	5.1	2.1	6.1	2.9									
30	5.7						2.9	0.9	4.5	1.3	5.1	1.9	6.1	2.7	6.6	4.1							
35	6.3						2.6	0.9	4.0	1.2	5.1	1.8	6.1	2.5	6.6	3.8							
40	7.0								3.7	1.1	5.1	1.7	6.1	2.3	6.6	3.5							
45	7.7								3.4	1.1	4.8	1.56	6.1	2.2	6.6	3.3							
50	8.2								3.2	1.0	4.5	1.5	6.1	2.1	6.6	3.2							
55	9.0										4.2	1.4	6.1	2.0	6.6	3.0							
60	10										3.9	1.4	5.8	1.9	6.6	2.9							
70	11										3.5	1.3	5.2	1.8	6.6	2.7	7.6	3.7					
80	12										3.2	1.2	4.7	1.6	6.6	2.5	7.6	3.5					
90	14										3.0	1.1	4.4	1.5	6.6	2.4	7.6	3.3					
100	15										2.7	1.1	4.1	1.5	6.2	2.2	7.6	3.1					
110	16												3.8	1.4	5.8	2.1	7.6	3.0					
120	18												3.6	1.3	5.5	2.0	7.6	2.8					
130	19												3.4	1.3	5.2	2.0	7.6	2.7	8.5	4.3			
140	20												3.2	1.2	4.9	1.9	7.6	2.6	8.5	4.1			
150	22														4.7	1.8	7.5	2.5	8.5	4.0			
160	23														4.5	1.8	7.2	2.5	8.5	3.8			
170	25														4.3	1.7	6.9	2.4	8.5	3.7	12	6.1	
180	26														4.1	1.7	6.6	2.3	8.5	3.6	12	5.9	
190	27														4.0	1.6	6.4	2.3	8.5	3.5	12	5.8	
200	28														3.8	1.6	6.1	2.2	8.5	3.4	12	5.6	
220	31																5.7	2.1	8.5	3.3	12	5.4	
240	34																5.4	2.0	8.5	3.1	12	5.1	
260																			8.5	3.0	12	4.9	
280																			8.2	2.9	12	4.7	
300																			7.9	2.8	12	4.6	
320																					12	4.4	
340																					12	4.3	
360																					12	4.2	
380																						11.6	4.1
400																						11.2	4.0



Fractional rigs, E_{max} and Y_{max} (m)

Section	RM 30 kNm	Displ. tonnes	B087		B104		B120		B135		B153		B172		B199		B250		B290		B380	
			E_{max}	Y_{max}	E_{max}	Y_{max}	E_{max}	Y_{max}	E_{max}	Y_{max}	E_{max}	Y_{max}	E_{max}	Y_{max}	E_{max}	Y_{max}	E_{max}	Y_{max}	E_{max}	Y_{max}	E_{max}	Y_{max}
6	1.2		3.4	1.4	4.1	1.6	4.1	1.8														
8	1.6		3.3	1.2	4.1	1.4	4.1	1.6	4.6	2.1												
10	2.0		2.8	1.1	3.7	1.2	4.1	1.4	4.6	1.9												
12	2.4		2.5	1.0	3.3	1.1	4.1	1.3	4.6	1.8												
14	2.8		2.2	0.9	3.0	1.0	4.1	1.2	4.6	1.6	5.1	2.5										
16	3.2		2.0	0.9			2.7	1.0	3.7	1.1	4.6	1.5	5.1	2.3								
18	3.6				2.5	0.9	3.4	1.0	4.6	1.4	5.1	2.2	6.1	3.0								
20	4.0						3.2	1.0	4.6	1.4	5.1	2.1	6.1	2.8								
25	5.0						2.7	0.9	4.3	1.2	5.1	1.8	6.1	2.5	6.6	3.8						
30	5.7								3.8	1.1	5.1	1.7	6.1	2.3	6.6	3.5						
35	6.3								3.4	1.0	4.8	1.6	6.1	2.1	6.6	3.2						
40	7.0								3.1	1.0	4.3	1.4	6.1	2.0	6.6	3.0						
45	7.7										4.0	1.4	5.9	1.9	6.6	2.9						
50	8.2										3.7	1.3	5.5	1.8	6.6	2.7						
55	9.0										3.5	1.2	5.1	1.7	6.6	2.6	7.6	3.6				
60	10										3.3	1.2	4.8	1.6	6.6	2.5	7.6	3.5				
70	11										2.9	1.1	4.3	1.5	6.6	2.3	7.6	3.2				
80	12												4.0	1.4	6.0	2.1	7.6	3.0				
90	14												3.6	1.3	5.6	2.0	7.6	2.8				
100	15												3.4	1.3	5.2	1.9	7.6	2.7				
110	16												3.2	1.2	4.8	1.8	7.6	2.6				
120	18														4.5	1.8	7.3	2.4				
130	19														4.3	1.7	6.9	2.3	8.5	3.7		
140	20														4.1	1.6	6.6	2.3	8.5	3.5		
150	22														3.9	1.6	6.2	2.2	8.5	3.4		
160	23														3.7	1.5	6.0	2.1	8.5	3.3		
170	25														3.6	1.5	5.7	2.1	8.5	3.2	12.0	5.2
180	26														3.4	1.4	5.5	2.0	8.5	3.1	12.0	5.1
190	27														3.3	1.4	5.3	1.9	8.5	3.0	12.0	5.0
200	28																5.1	1.9	8.5	3.0	12.0	4.8
220	31																4.8	1.8	8.1	2.8	12.0	4.6
240	34																4.5	1.7	7.6	2.7	12.0	4.4
260																			7.2	2.6	12.0	4.2
280																			6.8	2.5	11.9	4.1
300																			6.5	2.4	11.4	3.9
320																					10.9	3.8
340																					10.4	3.7
360																					10.0	3.6
380																					9.6	3.5
400																					9.3	3.4

Booms for slab reef, Single Line Reef and furling masts

After you have determined the correct boom section for your yacht (previous tables), all you have to do is decide what kind of reefing system you prefer. Then check the tables below to find the complete boom in question. If you are in any doubt about which boom to choose, please contact your Seldén dealer for expert advice. When fitting a Seldén boom to a mast of another brand, check the existing toggle's dimensions for compatibility.

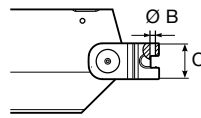

* Boom connects directly to gooseneck bracket. (B190 and B230)

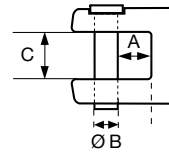

B087-B290

Booms for furling masts

Art. No.	Boom section	E _{max} mm
BS 120-72B	B120	3505
BS 120-73B		4005
BS 135-72	B135	4055
BS 135-73		4555
BS 153-72	B153	4520
BS 153-73		5020
BS 153-74		5520
BS 172-71	B172	4530
BS 172-72		5030
BS 172-73		5530
BS 172-74		6130
BS 199-71	B199	5530
BS 199-72		6630
BS 250-71B	B250	5610
BS 250-72B		6110
BS 250-73B		7110
BS 250-74B		7510
BS 290-71	B290	6885
BS 290-73		8385

Inboard end

Boom section	A mm	B mm	C mm
B087	8	8	16
B104	8	8	16
B120	14	10	20
B135	14	12	20
B153	13	12	21
B172	16	12	20
B199	21	16	30
B250	18	16	30
B290	30	16	30
B190*	-	12.2	78
B230*	-	12.2	78



Slab reef and Single Line Reef booms

Art. No.	Boom section	E _{max} mm	Remarks
BS 087-01	B087	3365	Outhaul (2:1) + 2 reefs, aft
BS 087-21		3365	Outhaul (4:1) + 2 reefs, cam cleats
BS 087-61		3365	Outhaul (2:1) + 2 Single Line Reef, aft
BS 104-01	B104	3515	Outhaul (2:1) + 2 reefs, aft
BS 104-02		4015	Outhaul (2:1) + 2 reefs, aft
BS 104-21		3515	Outhaul (4:1) + 2 reefs, cam cleats
BS 104-22		4015	Outhaul (4:1) + 2 reefs, cam cleats
BS 104-61		3515	Outhaul (2:1) + 2 Single Line Reef, aft
BS 104-62		4015	Outhaul (2:1) + 2 Single Line Reef, aft
BS 120-03B	B120	4040	Outhaul (3:1) + 2 reefs, aft
BS 120-23		4135	Outhaul (3:1) + 2 reefs, jam levers
BS 120-63B		4040	Outhaul (3:1) + 2 Single Line Reef, aft
BS 135-02	B135	4105	Outhaul (3:1) + 2 reefs, aft
BS 135-03		4605	Outhaul (3:1) + 2 reefs, aft
BS 135-22		4105	Outhaul (3:1) + 2 reefs, jam levers
BS 135-23		4605	Outhaul (3:1) + 2 reefs, jam levers
BS 135-62		4105	Outhaul (3:1) + 2 Single Line Reef, aft
BS 135-63		4605	Outhaul (3:1) + 2 Single Line Reef, aft
BS 153-02	B153	4570	Outhaul (3:1) + 3 reefs, aft
BS 153-03		5070	Outhaul (3:1) + 3 reefs, aft
BS 153-04		5570	Outhaul (3:1) + 3 reefs, aft
BS 153-22		4570	Outhaul (3:1) + 2 reefs, jam levers
BS 153-23		5070	Outhaul (3:1) + 2 reefs, jam levers
BS 153-24		5570	Outhaul (3:1) + 2 reefs, jam levers
BS 153-62		4570	Outhaul (3:1) + 2 Single Line Reef, aft
BS 153-63		5070	Outhaul (3:1) + 2 Single Line Reef, aft
BS 153-64		5570	Outhaul (3:1) + 2 Single Line Reef, aft
BS 172-01	B172	4580	Outhaul (3:1) + 3 reefs, aft
BS 172-02		5080	Outhaul (3:1) + 3 reefs, aft
BS 172-03		5580	Outhaul (3:1) + 3 reefs, aft
BS 172-04		6180	Outhaul (3:1) + 3 reefs, aft
BS 172-21		4580	Outhaul (3:1) + 3 reefs, jam levers
BS 172-22		5080	Outhaul (3:1) + 3 reefs, jam levers
BS 172-23		5580	Outhaul (3:1) + 3 reefs, jam levers
BS 172-24		6180	Outhaul (3:1) + 3 reefs, jam levers



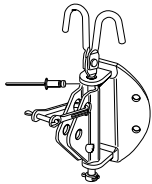
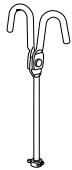
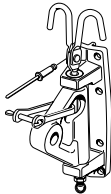
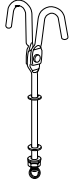
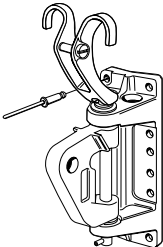

Aft = Lines to cockpit. Jam levers/cam cleats = Lines operated at gooseneck.

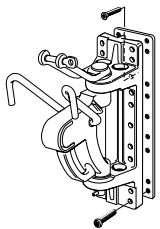
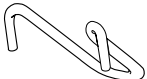
Art. No.	Boom section	E _{max} mm	Remarks
BS 172-61	B172	4580	Outhaul (3:1) + 2 Single Line Reef, aft
BS 172-62		5080	Outhaul (3:1) + 2 Single Line Reef, aft
BS 172-63		5580	Outhaul (3:1) + 2 Single Line Reef, aft
BS 172-64		6180	Outhaul (3:1) + 2 Single Line Reef, aft
BS 190-02	B190	4940	Outhaul + 2 reefs, aft
BS 190-03		5440	Outhaul + 2 reefs, aft
BS 190-62		4940	Outhaul + 2 Single Line Reef, aft
BS 190-63		5440	Outhaul + 2 Single Line Reef, aft
BS 199-01	B199	5590	Outhaul (4:1) + 3 reefs, aft
BS 199-02		6690	Outhaul (4:1) + 3 reefs, aft
BS 199-21		5590	Outhaul (4:1) + 3 reefs, jam levers
BS 199-22		6690	Outhaul (4:1) + 3 reefs, jam levers
BS 199-61		5590	Outhaul (4:1) + 2 Single Line Reef, aft
BS 199-62		6690	Outhaul (4:1) + 2 Single Line Reef, aft
BS 230-01	B230	4540	Outhaul + 2 reefs, aft
BS 230-02		4940	Outhaul + 2 reefs, aft
BS 230-03		5440	Outhaul + 2 reefs, aft
BS 230-04		6040	Outhaul + 2 reefs, aft
BS 230-61		4540	Outhaul + 2 Single Line Reef, aft
BS 230-62		4950	Outhaul + 2 Single Line Reef, aft
BS 230-63		5440	Outhaul + 2 Single Line Reef, aft
BS 230-64		6040	Outhaul + 2 Single Line Reef, aft
BS 250-01B	B250	5670	Outhaul (4:1) + 3 reefs, aft
BS 250-02B		6170	Outhaul (4:1) + 3 reefs, aft
BS 250-03B		7170	Outhaul (4:1) + 3 reefs, aft
BS 250-04B		7570	Outhaul (4:1) + 3 reefs, aft
BS 250-21B		5670	Outhaul (4:1) + 3 reefs, jam levers
BS 250-22B		6170	Outhaul (4:1) + 3 reefs, jam levers
BS 250-23B		7170	Outhaul (4:1) + 3 reefs, jam levers
BS 250-24B		7570	Outhaul (4:1) + 3 reefs, jam levers
BS 250-61B		5670	Outhaul (4:1) + 2 Single Line Reef, aft
BS 250-62B		6170	Outhaul (4:1) + 2 Single Line Reef, aft
BS 250-63B		7170	Outhaul (4:1) + 2 Single Line Reef, aft
BS 250-64B		7570	Outhaul (4:1) + 2 Single Line Reef, aft
BS 290-01	B290	6885	Outhaul + 2 reefs, aft
BS 290-03		8385	Outhaul + 2 reefs, aft
BS 290-61		6885	Outhaul (3:1) + 2 Single Line Reef, aft
BS 290-63		8385	Outhaul (3:1) + 2 Single Line Reef, aft

Boom brackets, E-sections, D-sections and R-sections

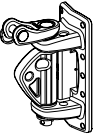
Fitting	Mast section	Boom bracket Art. No.	Boom type	Boom section	Dimension, mm	Fasteners Art. No.	Separate pin, hooks Art. No.
	For pear-shaped mast sections P100, P111	508-052-11 508-052-12	Single line reef (no hooks) Slab reef (with hooks)	B087 B104	Bracket Height: 80 Width: 63 Back angle: 45 Toggle Width: 13 Hole: Ø 8.2	4 pop rivets 167-004	Pin incl. reef hooks: 536-101-01 
		508-052-13 508-052-14	Single line reef (no hooks) Slab reef (with hooks)	B120	Toggle Width: 20 Hole: Ø 10		
	D109, D121 D129, D137 D146, D160 E122, E130 E138, E155 E170, E177, E189	508-040-07	Slab reef (with hooks)	B120	Bracket Height: 138 Width: 44 Back angle: 10° Toggle Width: 20 Hole: Ø 10.5	8 pop rivets 167-002	Pin incl. reef hooks: 536-102-01 
		508-040-01	Single line reef (no hooks)	111/75 128/90			
	E170, E177 E189, E206 E224, E237 E274	508-168-53 508-168-52	Slab reef (with hooks) Single line reef (no hooks)	143/76 B171 B172	Bracket Height: 179 Width: 63 Back angle: 10° Toggle Width: 20 Hole: Ø 12.5	12 pop rivets 167-002	Separate reef hooks: 536-113-01 Max. RM. Masthead 60 kNm Fractional 45 kNm 
		R190, R213 R235	508-168-21	Furling mast RA (no hooks)			
	E189, E206 E224, E237 E274	508-152-03	Slab reef (with hooks)	B199 B200	Bracket Height: 275 Width: 70 Back angle: 10° Toggle Width: 30 Hole: Ø 16.5	200/117 boom: 18 pop rivets 167-027	Separate reef hooks: 507-651 Max. RM. Masthead 120 kNm Fractional 90 kNm 
	E206, E224, E237, E274 E321, E365	508-152-23		B250		250/140 boom: 18 screws 155-803 + 2 screws 162-024 + backing plate	
	E189, E206 E224, E237 E274	508-152-02	Single line reef (no hooks)	B199 B200			
	E206, E224, E237, E274 E321, E365	508-152-22		B250			

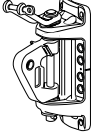

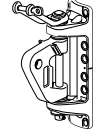
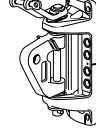
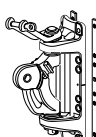
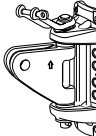
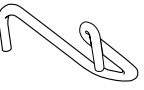
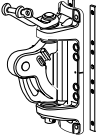
Boom brackets, C-sections and F-sections

Fitting	Mast section	Boom bracket Art. No.	Boom type	Boom section	Dimension, mm	Fasteners Art. No.	Separate pin, hooks Art. No.
	C137-C175	508-788-03	Single line reef (no hooks)	B087 B104	Bracket Height: 130 Width: 55 Toggle (AL) Width: 15 Hole: Ø 8	10 pop rivets 167-006	536-118
		508-788-05	Slab reefing (with hooks)				536-119-01
		508-788-04	Single line reef (no hooks)	B120	Toggle (AL) Width: 20 Hole: Ø 10		
		508-788-06	Slab reefing (with hooks)				
	F176-F194 C137-C193	508-231-33	Furling mast	B120	Bracket Height: 160 Width: 61 Toggle (AL) Width: 20 Hole: Ø 12.5	12 pop rivets 167-002	536-113-01 Max. RM: Masthead 55 kNm Fractional 40 kNm
		508-231-34	Single line reef (no hooks)				
		508-231-35	Slab reefing (with hooks)				
	F212-F246 C211-C245	508-257-33	Furling mast	B120	Bracket Height: 174 Width: 71 Toggle (AL) Width: 20 Hole: Ø 12.5		
		508-257-34	Single line reef (no hooks)				
		508-257-35	Slab reefing (with hooks)				
	F176-F194 C156-C193	508-231-06	Furling mast	B135 143/76 B152	Bracket Height: 160 Width: 61 Toggle (AL) Width: 20 Hole: Ø 12.5		
		508-231-07	Single line reef (no hooks)				
		508-231-08	Slab reefing (with hooks)				
	F212-F246 C211-C245	508-257-03	Furling mast	B135 143/76 B152 B171 B172	Bracket Height: 174 Width: 71 Toggle (AL) Width: 20 Hole: Ø 12.5		
		508-257-04	Single line reef (no hooks)				
		508-257-05	Slab reefing (with hooks)				
	F265-F286 C265-C285	508-233-03	Furling mast	B171 B172	Bracket Height: 242 Width: 81 Toggle (ST) Width: 20 Hole: Ø 12.5	12 screws 155-622 (MRT 6 x 25, in backing plate)	Separate reef hooks: 507-651 Max. RM: Masthead 120 kNm Fractional 90 kNm
		508-233-04	Single line reef (no hooks)				
		508-233-05*	Slab reefing (with hooks)			12 screws 155-621 (MRT 6 x 20, in backing plate)	
	F228-F246	508-233-36	Furling mast	B199 B200	Bracket Height: 242 Width: 81 Toggle (ST) Width: 30 Hole: Ø 16.5	12 screws 155-622 (M6)	
	508-152-38*	Slab reefing (with hooks)					
		F265-F305 C264-C304	508-233-08	Furling mast	B199 B200 B250 B290 B300	Bracket Height: 242 Width: 81 Toggle (ST) Width: 30 Hole: Ø 16.5	
508-233-09			Single line reef (no hooks)				
508-233-06*			Slab reefing (with hooks)				

AL = Aluminium ST = Stainless steel * Masthead RM30° >120 kNm or Fractional RM30° >90 kNm, use "floating hooks".

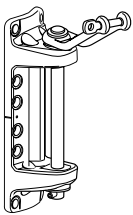

Boom brackets, Racing boom

Fitting	Mast section	Boom bracket Art. No.	Boom type	Boom section	Dimension, mm	Fasteners Art. No.	Separate pin, hooks Art. No.
	C175-C193	508-231-10	Slab reefing (with hooks)	B190 B230	Bracket Height: 160 Width: 71	12 screws 155-621 (MRT 6 x 20)	536-113-01 Max. RM: Masthead 55 kNm Fractional 40 kNm
		508-231-14	Single line reef (no hooks)	B190			
	C211-C245	508-257-07	Slab reefing (with hooks)	B190 B230	Bracket Height: 174 Width: 71		
		508-257-15	Single line reef (no hooks)				
							

Universal boom brackets

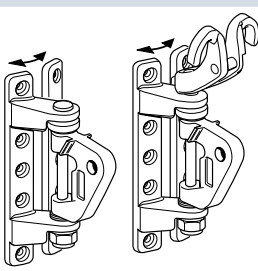
Fitting	Art. No.	Boom type	Boom section	Fasteners Art. No.
	508-237-05	Furling mast	B120	10 pop rivets 167-002 (Ø 6.4 x 17.8 MNL)
	508-237-08	Single line reef (no hooks)		
	508-237-11	Slab reefing (with hooks)		
	508-237-06	Furling mast	B135 143/76 B152 B171 B172	
	508-237-09	Single line reef (no hooks)		
	508-237-12	Slab reefing (with hooks)		
	508-237-07	Furling mast		
	508-237-10	Single line reef (no hooks)	B199 B200	
	508-237-13	Slab reefing (with hooks)		

These boom brackets are adjustable and fit most mast sections. Ideal when upgrading an old mast with a modern Seldén boom.

Reef line kits and sliders

Main sheet sliders

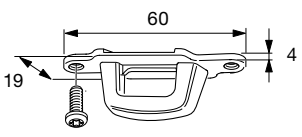
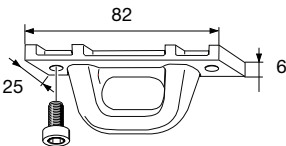
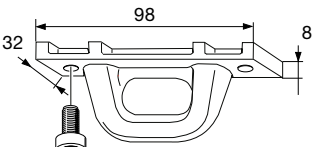
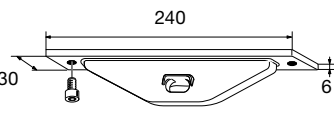
Fitting	Art. No.	Boom section
	511-641-01	B087 B104
	511-571-01	B120 B135 143/76 B152 B171 B172 B190*
	511-572-01	B199 B200 B230* B250
	511-616-01	B290 B300

* Webbing is often used as sheet attachment.

Single Line Reef kits

Boom section	Rope dia mm	Complete kit (reef 1 and 2 + outhaul) Art. No.	Excl. reef lines Art. No.
B120	8	611-007-10*	611-007-11
B135	10	611-011-14	611-011-15
B152	10	611-011-16	611-011-17
B171	10	611-011-12*	611-011-13
B171 (2008-)	10	611-011-24	611-011-25
/B172			
B200	12	611-015-04	-
B200 (2008-)	12	611-015-24	-
B250	12	611-015-25	-

Jam lever kits

Boom section	Art. No.
B135	511-074-21
143/76	511-072-11
B152	511-074-22
B153	511-278-10
B171	511-072-12 (-2007) 511-072-22 (2008-)
B172	511-280-10
B199	511-282-10
B200	511-071-11 (-2007) 511-071-21 (2008-)
B250	511-071-22

Lazyjack slider

Two part polyamide slider for Lazyjacks. Fits in the groove without removing the boom end.

For use with Lazyjacks and reef lines for loose footed sails only.

Fitting	Art. No.	Includes	B	Boom section
	511-636-01	One slider	18	B120-B172
	511-636-02	Two sliders with M6 screws (selftapping) and Ø 5.3 drillbit		
	511-637-01	One slider	25	B199- B290/300
	511-637-02	Two sliders with M6 screws (selftapping) and Ø 5.3 drillbit		



Retrofit outhaul track

This track can be retrofitted to an old boom and significantly improve the outhaul function.

A 400 mm long track with a ball bearing car is mounted in the sail track to simplify adjustment of the outhaul tension of a loose footed sail. A complete kit including track, traveller, end caps and fasteners (8 x 16 mm) for the sail track. Just remove the boom end, slide in the track and tighten the screws. Art. No. 511-580-11R. RCB22 / RM HM max.:40Nm / FRAC max.:30Nm 30°.





Rodkicker rigid vang

A Seldén Rodkicker facilitates sail handling when reefing, preventing the boom from dropping into the cockpit or onto the coach roof. When fitted with a Seldén gas spring, it lifts the boom when the kicking strap is released. Excellent for trimming the main in light air. The Seldén Rodkicker also doubles the purchase of your kicking strap.

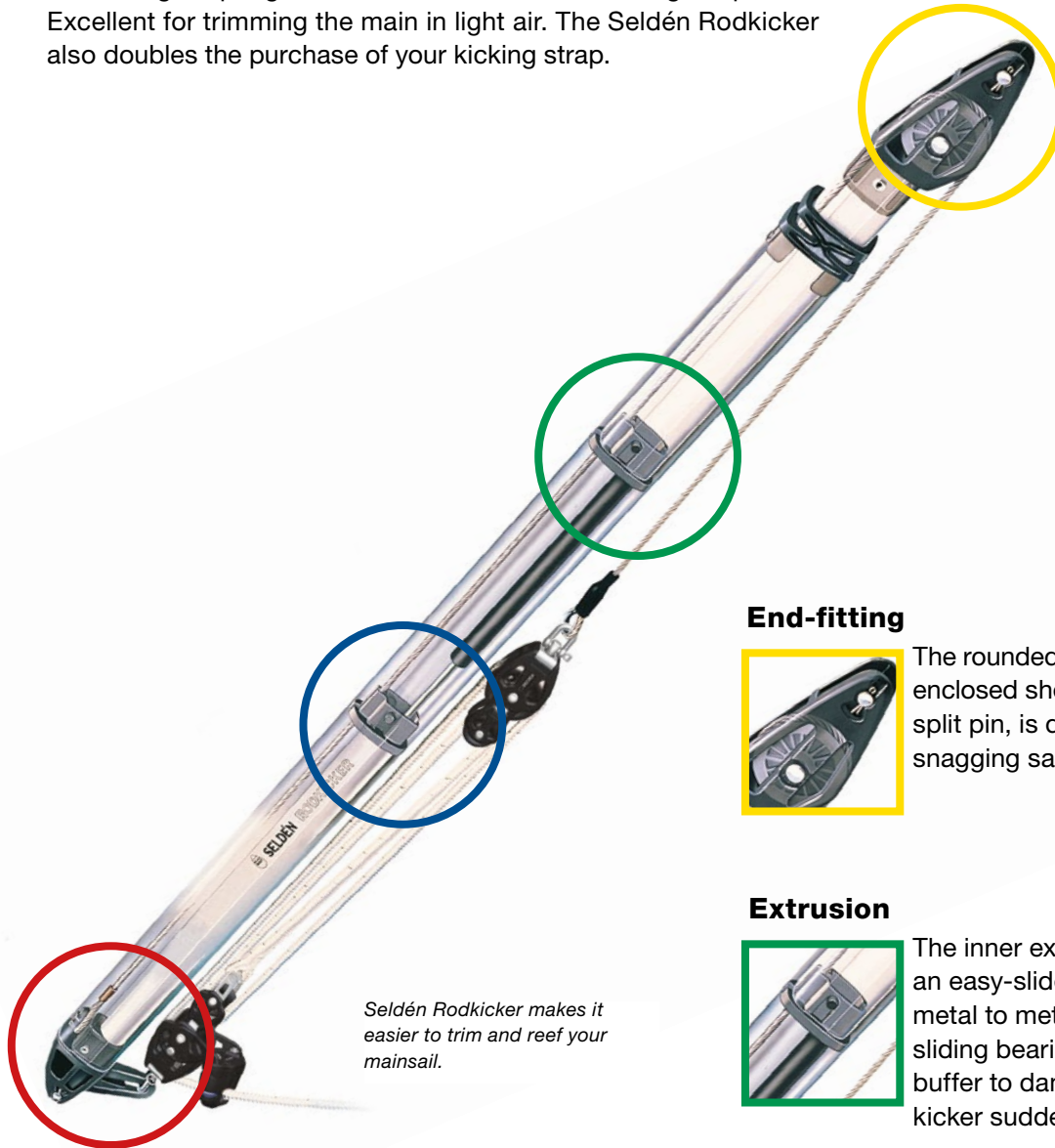

Seldén Rodkicker makes it easier to trim and reef your mainsail.

End-fitting



The rounded end-fitting, with enclosed sheave and recessed split pin, is designed to avoid snagging sails or crew.

Extrusion



The inner extrusion end plug acts as an easy-slide bushing and prevents metal to metal contact. The upper sliding bearing also acts as an elastic buffer to dampen the shock if the kicker suddenly bottoms.

Easily installed, easily operated



The extended block attachment lug allows the block to turn, enabling the tackle to be operated from either port or starboard. The Rodkicker is supplied with detailed instructions and is easily fitted.

If a Rodkicker is retrofitted to an existing rig, the original kicking strap tackle can still be used. Seldén Rodkickers are made of anodised aluminium and are carefully tested to meet stringent quality and performance standards.

Gas spring



The Rodkicker can be supplied with an optional integral gas spring. This lifts the boom when the kicking strap is released, opening the leech of the sail. A Rodkicker with a gas spring replaces the topping lift, making reefing fast and simple. The gas spring is easily retrofitted to a Rodkicker that does not have a spring. For spare gas springs, see page 73.

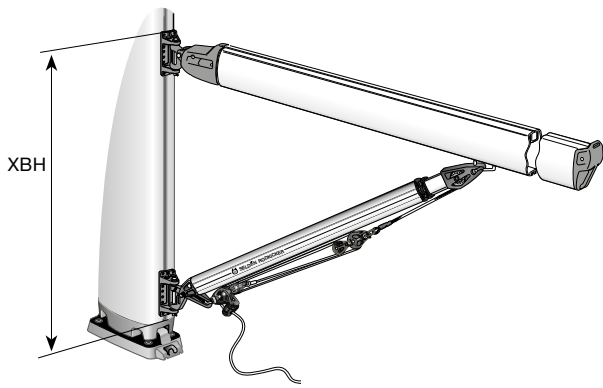

Operation from mast.

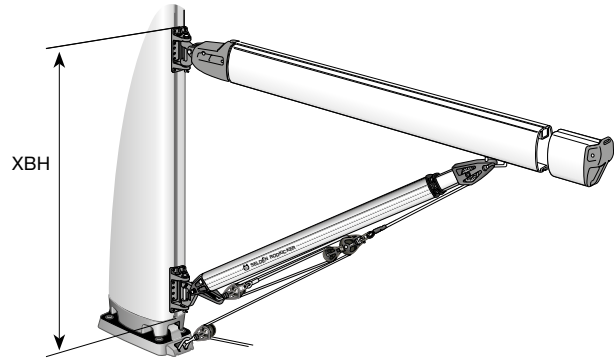



Operation from cockpit.

Choosing the right size

The choice is based mainly on the righting moment of the yacht, a measure of its ability to carry sail. This is approximately proportional to displacement. The second input is the rig type (masthead or fractional). The table below shows the correct type for monohulls.

Gas springs are available in a range of strengths, to cover variations in boom weight (including the stowed sail) and the Rodkicker angle. The angle varies with gooseneck height and kicker length. If in doubt, ask your dealer for more information.

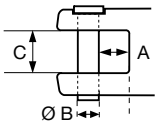
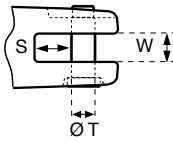
		Type 05		Type 10		Type 20		Type 30	
	Max. righting moment:	frac. rig masthead rig	12.5 kNm 15.0 kNm	25 kNm 35 kNm	50 kNm 70 kNm	120 kNm 160 kNm			
	Max. displacement:	frac. rig masthead rig	2.5 tonnes 3.9 tonnes	5 tonnes 6 tonnes	9 tonnes 11 tonnes	20 tonnes 25 tonnes			
	Current Seldén boom section Previous Seldén/Kemp boom section		B087-B120 86/59-111/75	B087-B152 86/59-111/75, 128/90	B171-B200 150/105-189/132, 206/139	B200-B250			
	Height of boom (XBH)		< 900 mm	≤ 1100 mm	> 1100 mm	≤ 1400 mm	> 1400 mm	≤ 1800 mm	> 1800 mm
	Type of Rodkicker		05 Standard	10 Standard	10 Long	20 Standard	20 Long	30 Standard	30 Long
	Min. length (L)		1150 mm	1360 mm	1670 mm	1720 mm	2260 mm	2200 mm	2700 mm
	Without gas spring*	Art. No.	058-036-05	058-036-10	058-036-13	076-046-10	076-046-13	094-056-10	094-056-13
	With gas spring (normal)*	Art. No. Spring force =	058-036-06 0.7 kN	058-036-11 0.6 kN	058-036-14 0.6 kN	076-046-11 1.2 kN	076-046-14 1.2 kN	094-056-11 2.5 kN	094-056-14 2.5 kN
	With gas spring (hard)*	Art. No. Spring force =	-	058-036-12 1.2 kN	058-036-15 1.2 kN	076-046-12 2.5 kN	076-046-15 2.5 kN	094-056-12 5 kN	094-056-15 5 kN
	With gas spring (extra hard)*	Art. No. Spring force =	-	058-036-16 2.5 kN	058-036-17 2.5 kN	076-046-16 5 kN	076-046-17 5 kN	-	-
Safe working load		8 kN	12 kN	18 kN	38 kN				
	Supplementary kit with normal gas spring	Art. No. Spring force =	308-038-03 0.7 kN 308-038 (gas spring only)	308-070-03 0.6 kN 308-070 (gas spring only)	308-071-03 1.2 kN 308-071 (gas spring only)	308-072-03 2.5 kN 308-072 (gas spring only)			
	Supplementary kit with hard gas spring	Art. No. Spring force =	-	308-071-04 1.2 kN 308-071 (gas spring only)	308-072-04 2.5 kN 308-072 (gas spring only)	308-073-04 5 kN 308-073 (gas spring only)			
	Supplementary kit with extra hard gas spring	Art. No. Spring force =	-	308-072-05 2.5 kN 308-072 (gas spring only)	308-073-05 5 kN 308-073 (gas spring only)	-			
	Lower fitting		Lower fitting A = 9, Ø B = 10, C = 20 Clevis pin 165-207	Lower fitting A = 9, Ø B = 10, C = 20 Clevis pin 165-207	Lower fitting A = 11, Ø B = 12, C = 20 Clevis pin 165-404	Lower fitting A = 14, Ø B = 16, C = 30 Clevis pin 165-556			
	Upper fitting		Upper fitting S = 7, Ø T = 10, W = 12 Clevis pin 165-205	Upper fitting S = 7, Ø T = 10, W = 12 Clevis pin 165-205	Upper fitting S = 12, Ø T = 12, W = 14 Clevis pin 165-409	Upper fitting S = 11, Ø T = 16, W = 16 Clevis pin 165-555			

* Kicking strap tackle not included.

Gas spring, conventional mast

Boom section 86/59	B087	B104	B120	B120	B135	143/76	B152	B171	B199	B199	B250	
							B153	B172	B200	B200		
Weight, kg/m	2	1.75	2.0	2.5	2.5	2.9	3.3	4.0	4.6	6	6	7.5
Circ., mm	240	240	300	330	330	370	390	420	460	550	550	680
XBH, mm				Maximum E* normal spring/hard spring/extra hard spring								
Rodkicker	Type 05			Type 10 (S/L)				Type 20 (S/L)		Type 30 (S/L)		
600	3.4	3.6	3.4	3.1	3.0/4.0/5.4 (S)	2.6/3.6/4.9 (S)	2.4/3.3/4.6 (S)					
700	3.7	3.8	3.7	3.4	3.3/4.4/- (S)	2.8/3.9/5.3 (S)	2.7/3.6/5.0 (S)					
800	3.9	4.0	3.8	3.6	3.4/4.6/- (S)	3.0/4.2/5.7 (S)	2.9/3.6/5.4 (S)	2.7/3.7/5.1 (S)	3.4/4.7/- (S)			
900	4.0	4.1	4.0	3.8	3.6/4.8/- (S)	3.2/4.4/- (S)	3.1/4.1/5.7 (S)	2.9/3.9/5.3 (S)	3.6/5.1/- (S)	-4.4/6.0 (S)	4.4/5.9 (S)	3.9/5.4 (S)
1000					3.7/5.0/- (S)	3.4/4.5/- (S)	3.2/4.3/5.9 (S)	3.0/4.1/5.5 (S)	3.8/5.3/- (S)	3.3/4.7/6.3 (S)	4.7/6.3 (S)	4.2/5.8 (S)
1100					3.9/5.2/- (S)	3.5/4.7/- (S)	3.4/4.6/6.2 (S)	3.1/4.3/5.9 (S)	4.0/5.5/- (S)	3.5/4.9/6.6 (S)	5.0/6.7 (S)	4.5/6.1 (S)
1200					4.0/5.4/- (L)	3.7/4.9/- (L)	3.5/4.7/6.4 (L)	3.2/4.4/6.0 (L)	4.2/5.7/- (S)	3.7/5.2/6.9 (S)	5.2/7.0 (S)	4.7/6.4 (S)
1300					4.2/- (L)	3.7/5.0/- (L)	3.6/4.8/6.5 (L)	3.3/4.5/6.2 (L)	4.3/5.8/- (S)	3.8/5.3/7.1 (S)	5.4/7.2 (S)	4.9/6.6 (S)
1400							3.6/4.9/6.6 (L)	3.4/4.6/6.3 (L)	4.4/6.0/- (S)	3.9/5.4/7.3 (S)	5.6/7.4 (S)	5.0/6.8 (S)
1500									4.6/6.3/- (L)	4.0/5.5/7.4 (S)	5.7/7.7 (S)	5.2/7.0 (S)
1600									4.7/6.4/- (L)	4.3/5.9/7.9 (L)	5.9/7.8 (S)	5.3/7.2 (S)
1700										4.3/6.0/8.0 (L)	6.0/8.0 (S)	5.4/7.4 (S)
1800											6.2/8.3 (L)	5.5/7.5 (L)
1900												5.8/7.8 (L)
2000												5.9/8.0 (L)



Rodkicker Type 05.

Gas spring, furling mast

Boom section	B120	B120	B135	143/76	B152	B171	B199	B199	B250	
					B153	B172	B200	B200		
Weight, kg/m	2.5	2.5	2.9	3.3	4	4.6	6	6	7.5	
Circ., mm	330	330	370	390	420	460	550	550	680	
XBH, mm		Maximum E* normal spring/hard spring/extra hard spring								
Rodkicker	Type 05	Type 10 (S/L)			Type 20 (S/L)		Type 30 (S/L)			
600	3.5	3.3/4.5/- (S)	2.8/4.0/- (S)	2.3/3.4/5.0 (S)						
700	4.0	3.7/5.4/- (S)	3.2/4.5/- (S)	2.7/3.9/5.7 (S)	2.5/3.6/5.3 (S)					
800	4.3	4.0/5.8/- (S)	3.5/5.0/- (S)	3.0/4.3/6.4 (S)	2.8/4.0/5.8 (S)	3.6/5.2/- (S)				
900		4.3/5.9/- (S)	3.7/5.3/- (S)	3.3/4.7/6.9 (S)	3.0/4.4/6.3 (S)	3.9/5.7/- (S)	-4.6/6.6 (S)	4.4/6.3 (S)	3.8/5.4 (S)	
1000		4.5/- (S)	3.9/5.5/- (S)	3.5/5.0/- (S)	3.2/4.7/- (S)	4.2/6.2/- (S)	-5.1/7.3 (S)	4.9/7.0 (S)**	4.2/6.0 (S)	
1100		4.7/- (S)	4.1/5.9/- (S)	3.7/5.4/- (S)	3.4/4.9/- (S)	4.5/6.6/- (S)	-5.5/7.9 (S)	5.4/7.6 (S)	4.6/6.6 (S)	
1200		5.0/- (L)	4.2/- (L)	3.9/5.6/- (L)	3.6/5.2/- (L)	4.7/6.8/- (S)	3.9/5.8/8.4 (S)	5.8/8.2 (S)	4.9/7.1 (S)	
1300		5.2/- (L)	4.3/- (L)	4.0/5.8/- (L)	3.7/5.3/- (L)	4.9/7.1/- (S)	4.1/6.1/8.7 (S)	6.1/8.7 (S)	5.2/7.5 (S)	
1400				4.1/5.9/- (L)	3.8/5.4/- (L)	5.0/7.3/- (S)	4.3/6.3/9.0 (S)	6.4/9.2 (S)	5.5/7.9 (S)	
1500						5.3/- (L)	4.4/5.6/9.3 (S)	6.7/- (S)	5.8/8.2 (S)	
1600						5.4/- (L)	4.7/6.9/- (L)	6.9/- (S)	5.9/8.5 (S)	
1700							4.9/7.1/- (L)	7.1/- (S)	6.2/8.8 (S)	
1800								7.4/- (S)	6.3/9.0 (S)	
1900								7.6/- (L)	6.6/9.4 (L)	
2000									6.7/9.6 (L)	

S = Standard L = Long XBH: See page 69.

Circ. = Circumference (lists extend beyond the Seldén boom range, to allow selection of the correct Rodkicker for other booms).

* The maximum E (sail foot length). ** Boom slider 511-599-01 required.

Rodkicker brackets



Rodkicker mast brackets, C-sections and F-sections

	Mast section	Boom section	Rodkicker brackets Type 05, 10 & 20 Art. No.	Rodkicker Type 30	Bracket dimensions	Fasteners Art. No.
	C137-C175	B087-B104	508-788-12 Toggle (AL): Width: 20 mm Hole: Ø 10 mm		Height: 130 mm Width: 55 mm	10 pop rivets 167-006
	F176-F194 C137-C193	B120-B172	508-231-12 Toggle (AL): Width: 20 mm Hole: Ø 12,5 mm		Height: 160 mm Width: 61 mm	12 pop rivets 167-002
	C211-C245	B120-B200	508-257-12 Toggle (AL): Width: 20 mm Hole: Ø 12,5 mm	508-257-14 Toggle (ST): Width: 30 mm Hole: Ø 16,5 mm	Height: 174 mm Width: 71 mm	
	F212-F246	B120-B200	508-257-22 Toggle (ST): Width: 20 mm Hole: Ø 12,5 mm	508-257-24 Toggle (ST): Width: 30 mm Hole: Ø 16,5 mm		
	C264-C304	B171-B250	508-233-12 Toggle (ST): Width: 15 mm Hole: Ø 16,5 mm		Height: 242 mm Width: 81 mm	12 screws 155-621 (MRT 6 x 20, in backing plate)
	F265-F305	B171-B250	508-233-22 Toggle (ST): Width: 15 mm Hole: Ø 16,5 mm			12 screws 155-622 (MRT 6 x 25, in backing plate + 2 pop rivets 167-008)
	F265-F305	B200-B250		508-233-24 Toggle (ST): Width: 30 mm Hole: Ø 16,5 mm		
	C264-C304	B200-B250		508-233-14 Toggle (ST): Width: 30 mm Hole: Ø 16,5 mm		

AL = Aluminium ST = Stainless steel

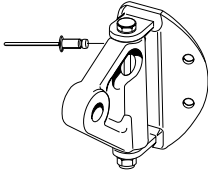
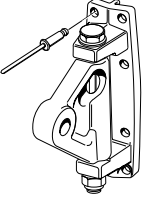
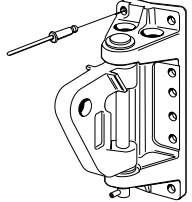
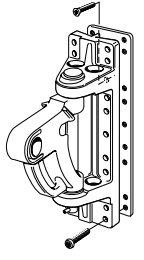

Rodkicker mast brackets, E-sections, D-sections and R-sections

Fitting	Mast section	Kicker brackets (incl. fasteners) Art. No.	Dimensions mm	Boom section	Rodkicker Type	Fasteners Art. No.	Fasteners dia. x length mm	
	For pear shaped mast sections	508-052-03	Bracket Height: 80 Width: 63 Back angle: 45° Toggle Width: 20 Hole: Ø 10.5	86/59 85/58	05 10	4 pop rivets 167-004	6.4 x 12.7	
	D109, D121, D129, D137, D146, D160 E122, E130, E138, E155, E170,	508-040-03	Bracket Height: 138 Width: 44 Back angle: 10° Toggle Width: 20 Hole: Ø 10,5	B120 111/75 128/90	05 10	8 pop rivets 167-002	6.4 x 17.8	
	E-sections from E170	508-168-62	Bracket Height: 179 Width: 63 Back angle: 10° Toggle Width: 20 Hole: Ø 12,5	143/76 B171 B172	10 20	12 pop rivets 167-002	6.4 x 17,8	
	R190, R213, R235	508-168-32				10 20	12 pop rivets 167-0002	6.4 x 17.8
	R232, R260	508-151-12				10 20	10 pop rivets 167-002 + backing plate	6.4 x 17,8
	E-sections from E189	508-152-12	Bracket Height: 275 Width: 70 Back angle: 10° Toggle Width: 30 Hole: Ø 16.5	B199 B200	30	18 pop rivets 167-027	6.4 x 25	
		508-152-32		B250	30	18 screws 155-803 + 2 screws 162-024	MRT 6 x 50 +MFT 6 x 40 + backing plate	
	R-section	508-153-32		B199 B200 B250	30	10 screws 155-802 + 9 x 155-622 + 6 x 162-032 + backing plate	MRT 6 x 30 + MRT 6 x 25 + MFT 6 x 25	



Rodkicker boom brackets

Description, mm	Art. No.	Boom section	Rodkicker Type
	511-643-01	B087, B104	05 10
	511-800-01	B120, 111/75 B135, 128/90 143/76, 150/105 B152, 162/125 B171, B172, B190	05 10 20
	511-801-01	B199 B200, B230 B250	30
	511-599-01	B300 B290	30
	Slider 511-513-01 Track 515-504-05 (Radius 34) 515-501-03 (Radius 50)		10
	Slider 511-513-02 Track 515-501-04 (Radius 50)		20

Universal boom brackets

	Art. No.	Dimensions mm	Rodkicker Type	Fasteners
	508-403-01	Length: 250 Width: 9	10 20	6 screws included
	508-403-02	Hole: Ø 13		6 pop rivets included

Please visit: www.seldenmast.com for assembly instructions.

Universal mast brackets

	Art. No.	Dimensions mm	Rodkicker Type	Fasteners
	508-237-01	Bracket	10	No fasteners incl.
	508-237-02	Height: 185 Toggle	20	10 screws included
	508-237-03	Width: 20 Hole: Ø 12.5		10 pop rivets incl.



A Seldén furling mast lets you operate your mainsail from the cockpit, simply and easily. Its unique features for reducing friction and initial sail resistance make furling and reefing child's play. And it also makes sailing safer and far easier for you and your crew.

FURLING MASTS

manual and electric drive



The benefits of furling masts	80
Furling masts, manual	83
Furling masts, electric drive	86
Furling mast specification	88

For hydraulic furling masts,
see page 122.

With a powered furling mast and a powered Furlex jib furler it is even easier to set, reef and handle your sails. You can work your sails single handed, without leaving the helm. Powered systems are available for yachts ranging from 35 to 70 feet.

Let your rig do the hard work



Simple

You hoist the sail just once a season, so a small crew can manage a much larger boat.

Easy

A Seldén furling mast makes it easy to unroll and set your mainsail. Rolling it in is just as quick and easy. As your sail is neatly stowed out of the way the instant it is rolled in, you have a clear view when manoeuvring under power.



Safe

You can set your sail to suit the weather conditions, from the safety of the cockpit.

Efficient

By furling the sail vertically into the mast, you don't have to furl very much to get a substantial decrease of the sail area.



Well balanced

There are no fixed reef points, so the number of combinations between furling genoa and main are unlimited.

More enjoyable

Due to the easy handling, with a furling mast you will do more sailing and less motoring.

Vertical battens allow for a positive roach on the furling mainsail. A fine combination of performance and convenience.



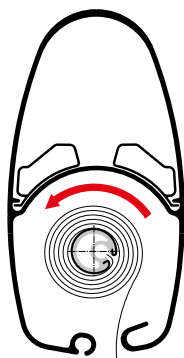
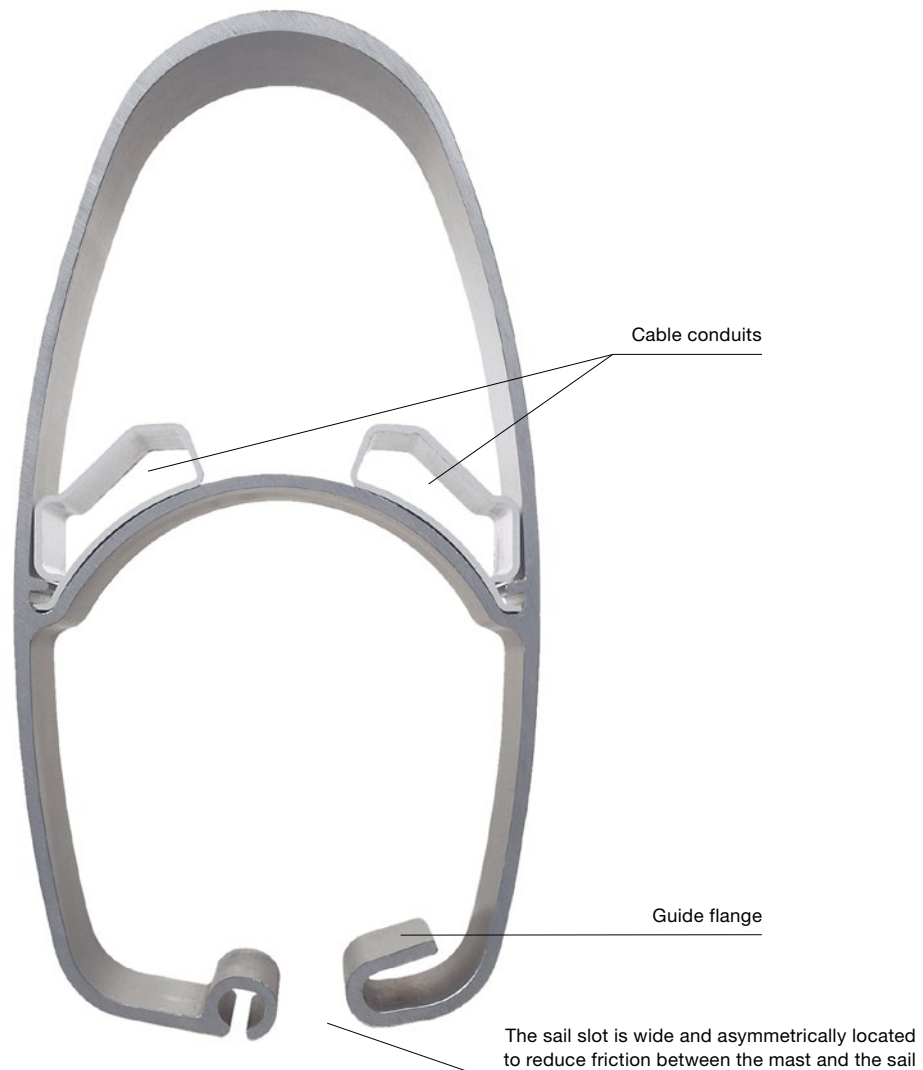

Cross-section of a Seldén furling mast.

The Seldén furling principle

The wide sail slot allows for vertical battens and a positive roach of the main sail.

The actual sail slot is placed asymmetrically to reduce furling resistance and to lead the sail straight on to the internal luff extrusion.

The furling system is based on Seldén's proven technology. Geared line driver winch, tensioned luff extrusion, asymmetrically located sail slot and the patented load distributor of the halyard swivel. All to make furling an easy and fast operation. The Seldén furling masts come with twin cable conduits, enabling the cables to run freely and well protected from all running rigging. The cable conduits also facilitate cable replacement.

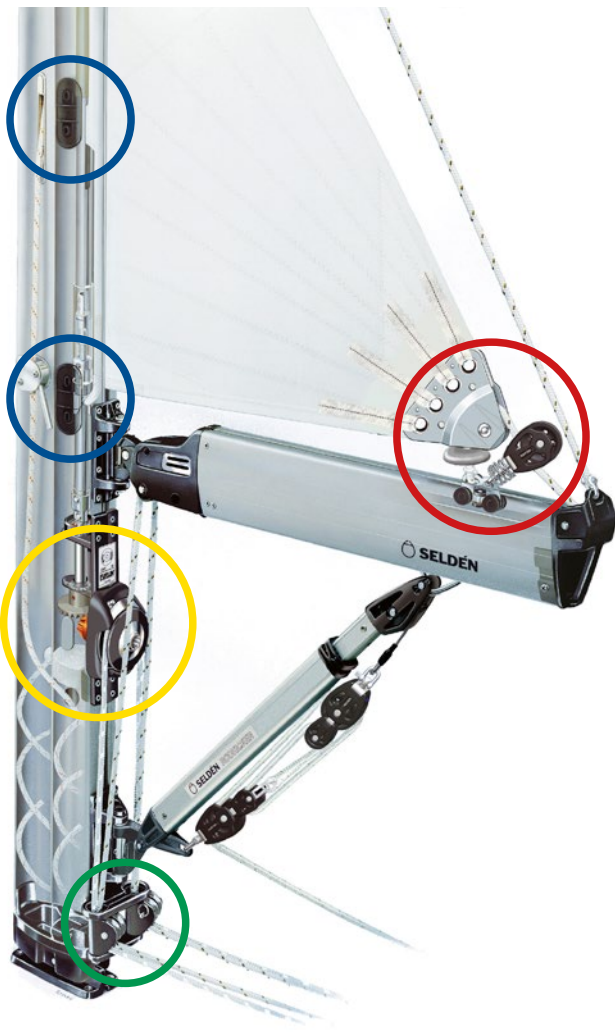

● **Easy to operate**

There is an outhaul line for rolling out the sail, and an endless line for rolling it in. It's as simple as it sounds. Or if you wish, you can operate the sail at the mast using a winch handle. The geared reefing winch mechanism runs on ball bearings, so it takes little effort to roll in the sail. Greasing holes in the mast facilitate maintenance.

● **Accessible**

Two oval holes on the port side of the mast allow for easy access to the tack attachment, sail feed, tensioning screw and halyard swivel. Just remove the composite covers and the rest speaks for itself. You can inspect the halyard swivel and carry out annual maintenance through the upper access hole.

● **Absorbs all sail forces**

The outhaul cars are fitted with horizontal and vertical wheels, enabling them to absorb forces from every direction.

● **Turning block for control lines**

Turning blocks at the base of the mast are designed to enable the ready-spliced, endless line to be easily threaded into position. Seldén deck blocks have the same feature.

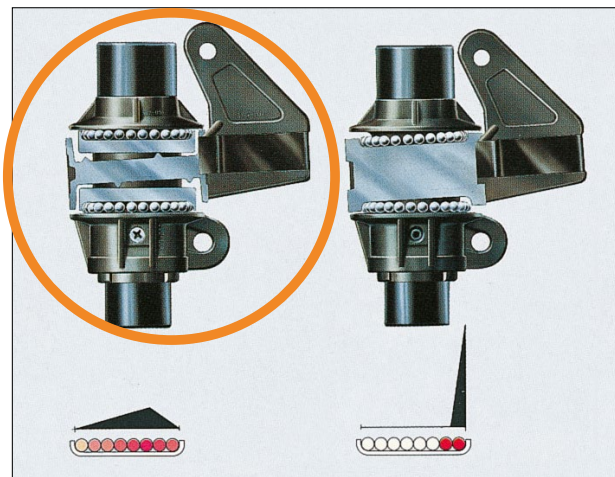

The Seldén load distributor prevents...

... point loading!

Seldén's unique load distributor

The furling mechanism rotates easily even under high load. This is largely due to the unique bearing system in the halyard swivel, which was originally developed for the Furlex jib furling system. The cleverly designed load distributor has three fulcrums, distributing the load over the entire bearing race and all the bearings, rather than over small areas of the race.



Low friction

The asymmetric design and large radius edges of the slot reduce sail friction, making it much easier to roll the sail in and out. The sail groove on the luff extrusion is located asymmetrically to help the sail furl easily around the extrusion. In addition, the rotating luff extrusion is tensioned and fitted with ball bearings top and bottom. This reduces friction between the sail and the inside of the sail compartment.

Synchronized main furling, SMF

To make sail handling easier for a small crew we have synchronized an electric motor in the mast with a newly developed electric winch for the outhaul, E40i. Push a button and the sail comes out in a controlled fashion as the winch adjusts the outhaul tension in relation to the motor in the mast.



In-mast furling motor

Converting a manually operated furling mast is quite easy. Basically, the vertical shaft in the original line driver is replaced for a longer version which is connected to the motor. A clutch allows the motor to be disconnected for manual operation, if ever needed. The motor is completely integrated in the mast and connected to the Seldén Power Supply and SEL-Bus system.

The motor can be retrofitted to Seldén furling masts type RB (~36-43' yachts).

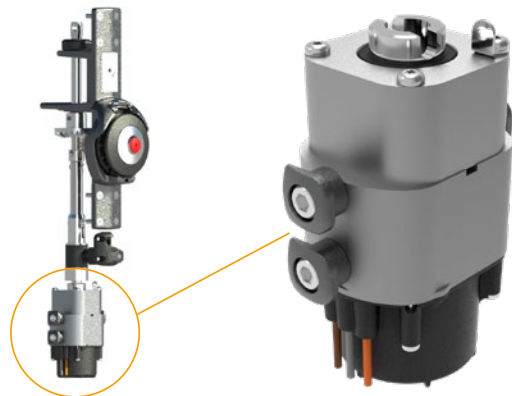

Push buttons

Push the "OUT" button and the sail will start to unfurl. The E40i winch will tension up the outhaul while the mast motor feeds out the sail. The speed is increased when the "IN" button is pushed in addition to "OUT". To reef, just release the outhaul from the winch and push "IN".

E40i Electric winch

The E40i winch is built up around an electric motor which is totally integrated in the drum. Only three thin cables are protruding to lead through the coach roof or the deck, no large cutouts and no external motor or gearbox. This makes for uncompromised headroom down below which is normally not the case with electric winches.

The three speed operation provides a high speed gear, a moderate gear and a low speed gear for fine tuning. It is a two finger operation to start the winch and to switch gear, so a single-handed sailor can helm while adjusting the trim.



Power supply & SEL-Bus system

The Seldén Power Supply System converts 12V or 24V to 42V which allows for smaller motors and thinner cables. Each electric function has a dedicated motor control unit and as they are connected through a Can Bus system, named "SEL-Bus", they communicate for smooth operation of the sail without overloads.

When not in use, the system will switch into sleep mode to save power.

1. Battery
2. Main switch/fuse
3. Power Supply Unit (PSU). Converts 12/24V to 42V
4. Push buttons for Synchronized Main Furling
5. E40i electric winch
6. Motor Control Unit (MCU), E40i
7. Push buttons for E40i
8. Mast motor
9. Motor Control Unit (MCU), mast motor
10. SEL-Bus backbone cables and connections

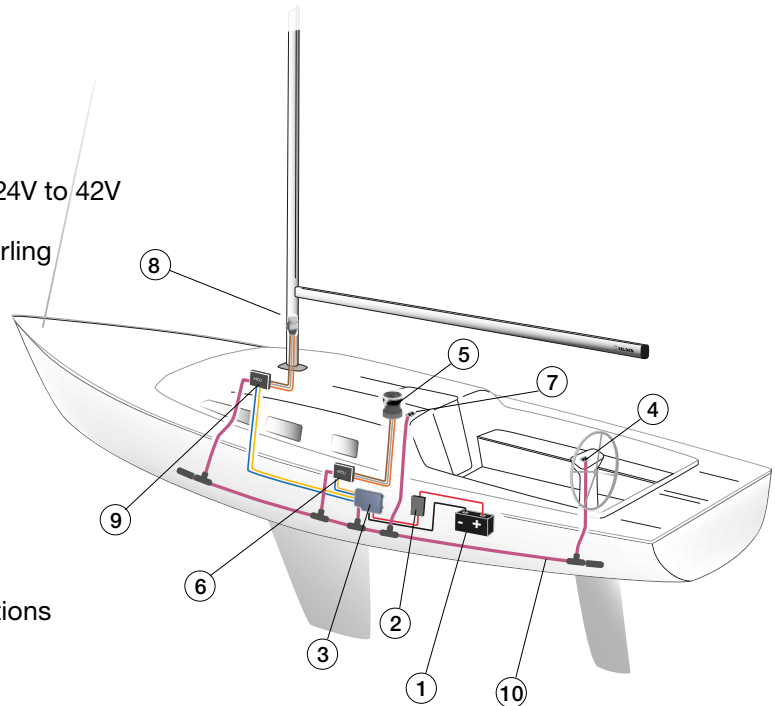

Mast sections that can be upgraded to SMF

Mast section	Section dimensions, mm Long/Lat	Production years
R232	232/126	1986-2002
R260	260/136	1986-2002
F228*	228/118	2002-
F246	246/126	2002-
F265*	265/135	2002-
F286*	286/146	2002-
F305*	305/156	2002-

*These sections have been combined with RA, RB or RC furling systems. SMF is only available for RB systems featuring a $\varnothing 30$ mm furling extrusion (RA = $\varnothing 25$ mm and RC = 38 mm).





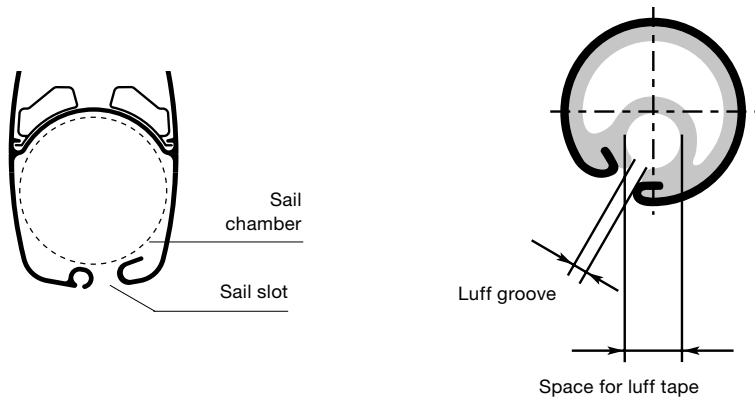

Seldén furling mast specifications

Mast section	Type	Sail chamber dia., mm	Sail slot mm	Max foot length E, mm	Drive options			Gear ratio manual drive	Diameter mm	Luff groove mm	Max space for luff tape dia., mm
					Manual	Hydraulic	Electric (Voltage)				
F176	RA	85	15±3	3750	X			1.75:1	25	2.75 ± 0,25	6
F194	RA	93		4200	X						
F212	RA	100		4500	X						
	RB			4400	X			2:1	30	3.25 ± 0,35	8
F228	RA	108		5000	X			1.75:1	25	2.75 ± 0,25	6
	RB			4900	X		X (12)				
F246	RB	114		5400	X	X	X (12)	-	38	3.25 ± 0,25	10
F265	RB	123	17±3	6000	X	X	X (12)				
	RC			5800	X	X	X (12/24)				
F286	RB	133		6500	X	X		-	30	3.25 ± 0,35	8
	RC			6300	X	X	X (12/24)				
F305	RB	141		6900	X	X		-	30	3.25 ± 0,35	8
	RC			6700	X	X	X (12/24)				
	RD			6000		X					
F324	RC	154	15±3	7000		X	X (12/24)	2:1	38	3.25 ± 0,25	10
F370	RD	171	22±3	7500		X					
F406	RD	190	24±3	9500		X		-	58		



Covers and plugs

	Description	Art. No.
	Cover for access to sail-feeder and tack attachment. 57 x 126 mm. F194-F246.	540-026
	Cover for access to sail-feeder and tack attachment. 72 x 207 mm. F265-F406.	540-120
	Grease hole cover, Ø 44 mm.	319-609



The Furlex jib furling and reefing system was first introduced in 1983. The basic concept was not new, but Furlex broke new ground with innovative design, attention to detail, good value and worldwide service backup. Today, Furlex is the world market leader, and a normal feature on any well equipped yacht.



The 4th generation of Furlex.

FURLEX

jib furling and reefing system



Furlex 50S (Standard)	92
Furlex 104-404S (Standard)	94
• Choose the right Furlex	96
• Toggles	100
• Furlex with rod forestay	101
Furlex TD (Through-Deck)	102
Furlex E (Electric)	104

For Furlex H (Hydraulic), see page 126.

Furlex 50S

jib furling system for boats 18-26 ft

The Furlex 50S is the perfect choice for every sailor who wants a compact, low weight furling system. It shares many features with the larger members of the world-famous Furlex family.

The patented load distributor in the halyard swivel and the full length distance tubes for smooth rotation are the same as on all the other Furlex models.

Furlex 50S is supplied as a complete kit including forestay wire, halyard lead, stanchion block, prefeeder and furling line. Easy to order and easy to install.

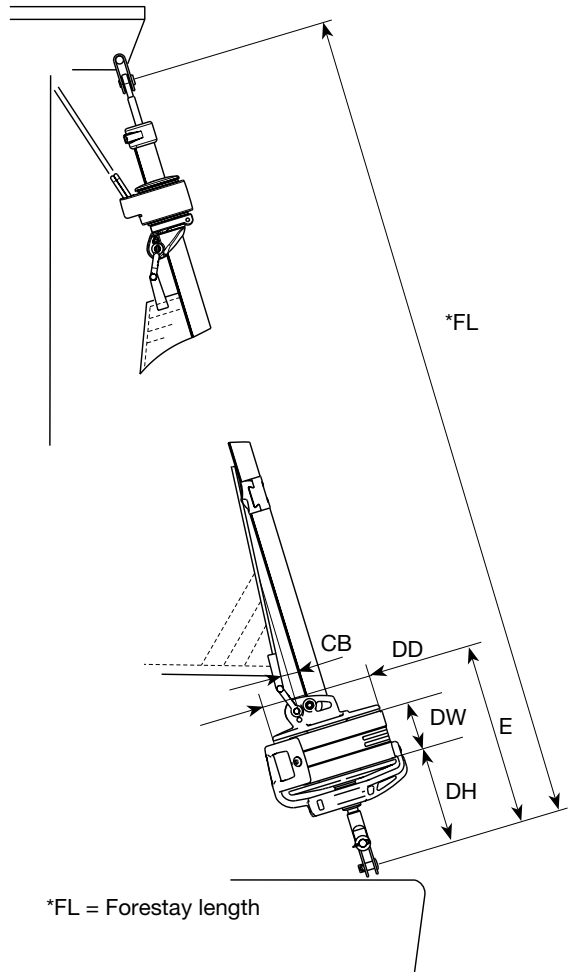

Choose the right Furlex

Furlex series	Fore-stay, dia., mm	Max righting moment (kNm) at 30° heel		Approx. displacement, tonnes		DH mm	DW mm	DD mm	CB mm	E mm	Halyard sheave box Art. No.
		Masthead rig	Fractional rig	Masthead rig	Fractional rig						
50S	4	6.5	8	1.4	1.7	100	60	120	25	215	505-004-10
	5	8.5	11	1.8	2.5	100	60	120	25	215	505-004-10

Furlex series	Forestay, dia., mm	Max forestay length (FL), m	Furlex system Art. No.
50S	4	7.7	022-015-51
	4	10.1	022-015-52
	5	7.7	022-015-53
	5	10.1	022-015-54
	5	12.5	022-015-55

Furlex series	Internal diameter of luff groove (DLG), Ø mm	Width of luff groove (WLG), mm
50S	6.0	2.6

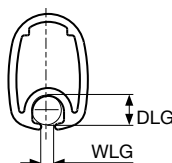

Ball bearings and ball bearing rings in marine grade stainless steel

Dyneema lashing

Stainless steel reinforcement in moulding

Patented load distributor for easy furling and long service life



Halyard swivel in composite with stainless steel reinforcement. Low weight (230 g). Low friction due to the load distributor.

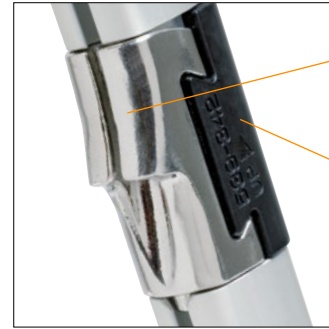

Stainless steel sail feeder for smooth hoisting of sail

Composite sail feeder connector

Uniform cross-section of extrusion from head to tack for better performance of a reefed sail

Single groove extrusion for 5 mm luff tape

Stainless steel reinforcement in moulding

High quality, glass fibre reinforced polyamide composite

Stainless steel insert for low friction line management

FURLEX
SELDEN

FURLEX

Sta-lok® wire terminal for easy installation

Fork/fork toggle for proper forestay articulation

Furlex 104S-404S (Standard)

The **4th** generation of an icon

The fourth generation of Furlex is an uncompromising evolution of the world's best selling jib furling and reefing system. Proven design blended with innovation is our way to maintain the iconic heritage of Furlex.

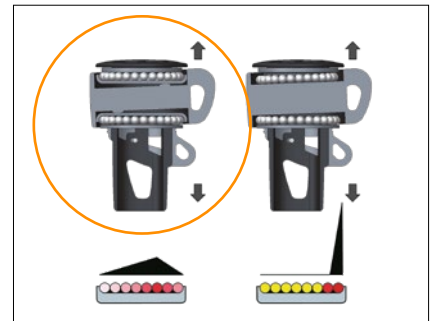

The Seldén load distributor prevents...

....point loading!



The halyard swivel for Furlex 104S and 404S features stainless ball bearings. The load is centered by the attachment of the Dyneema® lashing.



Ball bearings and ball bearing races made from marine grade stainless steel. Seldén's patented load distributor for Furlex 204S and 304S makes for low furling resistance and durability. This concept was launched in 1983 and it still performs flawlessly today.



The sail feeder is marine grade stainless steel. It is well rounded and kind to the sail.

The twin-groove luff extrusion and the split drum allow the racing sailor to convert the Furlex for racing. The cruising sailor can use the extrusion for 'wing on wing' downwind sailing with two genoas poled out to either side.

NEW Two sets of stainless ball bearings and one additional set of roller bearings for low friction and low lateral deflection.

Tack swivel with a 'free-turn' and a uniform cross section of the luff extrusion make for a perfectly furling sail and effective performance even when reefed. It also reduces the effort needed to furl that first turn.

NEW The tack ring has a smaller diameter compared to previous models and the shackle is also smaller. This combination reduces the initial furling resistance.

NEW Greater utilisation of modern composite material means 8% overall weight reduction which improves the sailing performance.

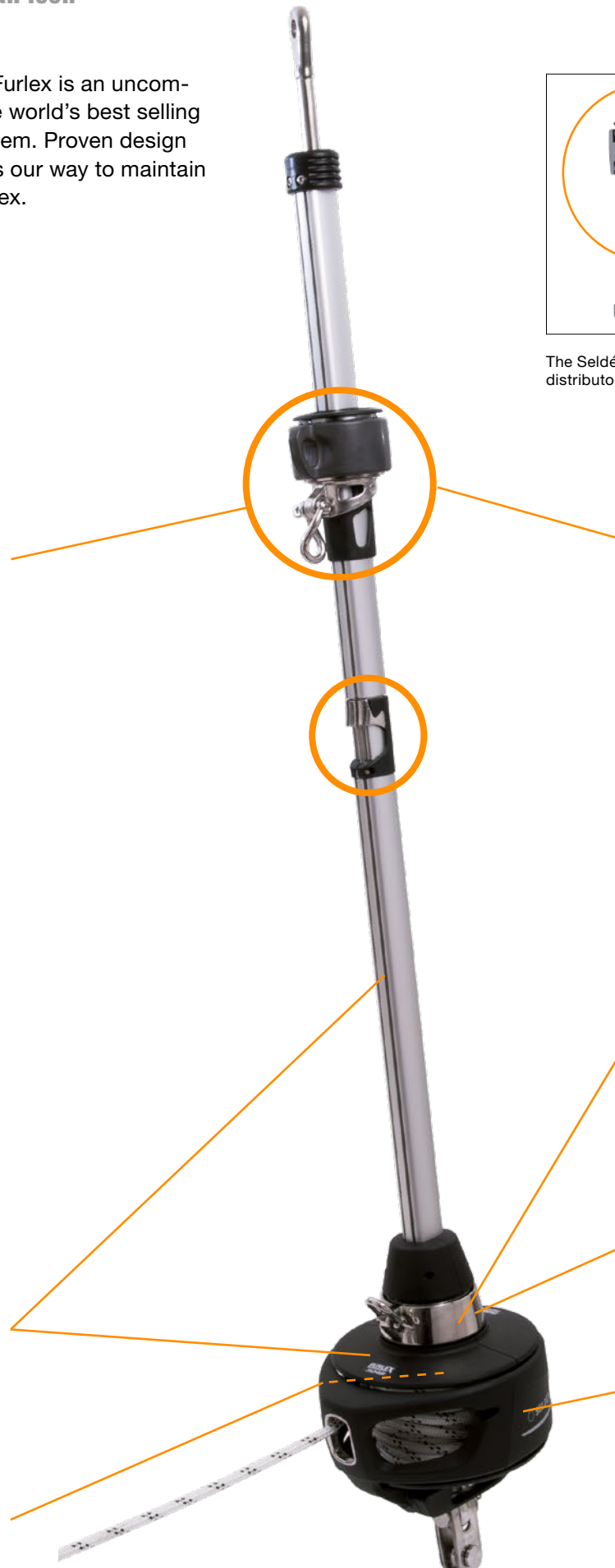

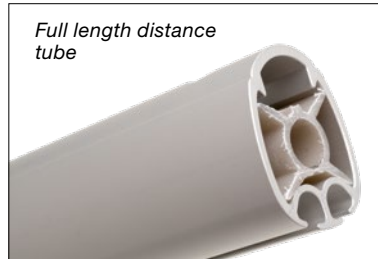

The forestay wire is centred and insulated the full length of the extrusion enabling the extrusion to rotate evenly around the wire. The furling resistance is reduced and chafe between the wire and the extrusion is eliminated.

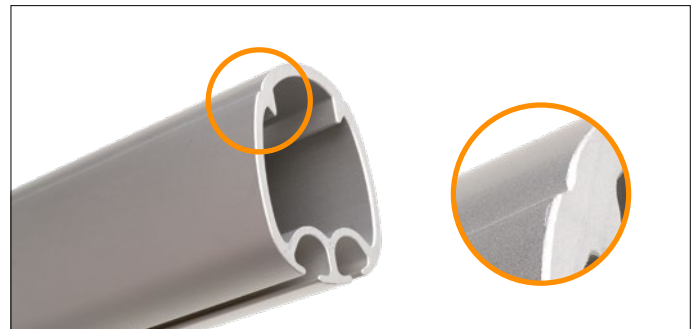

NEW The luff extrusion consists of 2400 mm sections connected with an aluminium joining sleeve and a stainless steel connecting plate. The joining sleeve transmits the torque within the extrusions, and the connecting plates keep the sections together with a slight gap between them. This way chafe is avoided on both the extrusions and the sail.

NEW The Furlex Aero Groove system reduces drag and creates improved flow over the luff extrusion and consequently, the sail.

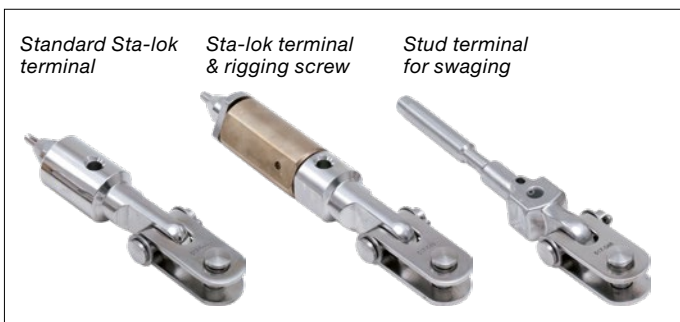

Similar to previous Furlex models, the standard kit requires that the wire is cut to length and fixed with a 'Sta-lok' mechanical wire locking system. A completely integrated rigging screw is offered as an option. It allows for adjustment of the forestay length without altering the height of the tack attachment.

Furlex, as in previous generations, comes as a complete kit including all parts needed for reliable and convenient furling of the foresail. It even includes a new forestay wire, furling line, stanchion lead blocks, a halyard lead and a prefeeder. A simple purchase.

NEW To simplify the final assembly at the dock, Furlex can now also be ordered with the forestay wire pre-cut to a specific length. Both ends of the wire are fitted with swaged terminals and the lower stud terminal can pass through the extrusions. This method of assembly does not include the option of an integrated rigging screw.

NEW If you already have a jib furler on your boat and do not need another set of stanchion blocks, halyard lead, prefeeder and Torx bits you can order a Basic kit in which these parts are excluded.

Choose the right Furlex



Complete kit.

Complete kit

Furlex	Forestay dia. Ø mm	Max. forestay length, mm	Complete kit including...		
			Standard Sta-lok terminal Art. No.	Sta-lok terminal & rigging screw Art. No.	Stud terminal for swaging Art. No.
104S	4	8100	030-020-51	030-020-61	030-020-91
		10500	030-020-52	030-020-62	030-020-92
	5	8100	030-020-53	030-020-63	030-020-93
		10500	030-020-54	030-020-64	030-020-94
		12900	030-020-55	030-020-65	030-020-95
	6	10500	030-020-56	030-020-66	030-020-96
12900		030-020-57	030-020-67	030-020-97	
204S	6	10550	035-025-51	035-025-61	035-025-91
		12950	035-025-52	035-025-62	035-025-92
		15350	035-025-53	035-025-63	035-025-93
	7	12950	035-025-54	035-025-64	035-025-94
		15350	035-025-55	035-025-65	035-025-95
		17750	035-025-56	035-025-66	035-025-96
	8	15350	035-025-57	035-025-67	035-025-97
		17750	035-025-58	035-025-68	035-025-98
304S	8	15450	042-031-51	042-031-61	042-031-91
		17850	042-031-52	042-031-62	042-031-92
	10	15480	042-031-53	042-031-63	042-031-93
		17880	042-031-54	042-031-64	042-031-94
		20280	042-031-55	042-031-65	042-031-95
404S	12	17700	052-038-51	052-038-61	052-038-91
		20100	052-038-52	052-038-62	052-038-92
		22500	052-038-53	052-038-63	052-038-93
	14	20100	052-038-54	052-038-64	052-038-94
		22500	052-038-55	052-038-65	052-038-95



Basic kit



In the basic kit of Furlex, stanchion blocks, pre feeder, halyard lead and Torx bits have been excluded.



A stainless steel cover is available as an option. Art. No. 549-228-10 (204S), 549-328-10 (304S) and 549-428-10 (404S).

Furlex	Forestay dia. Ø mm	Max. forestay length, mm	Basic kit including...		
			Sta-lok terminal (Standard) Art. nr.	Sta-lok terminal & rigging screw Art. No.	Stud terminal for swaging Art. No.
104S	4	8100	030-020-510	030-020-610	030-020-910
		10500	030-020-520	030-020-620	030-020-920
	5	8100	030-020-530	030-020-630	030-020-930
		10500	030-020-540	030-020-640	030-020-940
		12900	030-020-550	030-020-650	030-020-950
	6	10500	030-020-560	030-020-660	030-020-960
12900		030-020-570	030-020-670	030-020-970	
204S	6	10550	035-025-510	035-025-610	035-025-910
		12950	035-025-520	035-025-620	035-025-920
		15350	035-025-530	035-025-630	035-025-930
	7	12950	035-025-540	035-025-640	035-025-940
		15350	035-025-550	035-025-650	035-025-950
		17750	035-025-560	035-025-660	035-025-960
	8	15350	035-025-570	035-025-670	035-025-970
		17750	035-025-580	035-025-680	035-025-980
		17750	035-025-580	035-025-680	035-025-980
304S	8	15450	042-031-510	042-031-610	042-031-910
		17850	042-031-520	042-031-620	042-031-920
	10	15480	042-031-530	042-031-630	042-031-930
		17880	042-031-540	042-031-640	042-031-940
404S	12	20280	042-031-550	042-031-650	042-031-950
		17700	052-038-510	052-038-610	052-038-910
		20100	052-038-520	052-038-620	052-038-920
	14	22500	052-038-530	052-038-630	052-038-930
		20100	052-038-540	052-038-640	052-038-940
		22500	052-038-550	052-038-650	052-038-950





19-strand wire

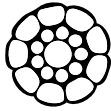

Compact wire (Dyform®)

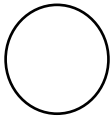

Rod

Furlex	Forestay dia. mm	Rod dia. mm	Max righting moment (kNm) at 30° heel		Approx. displacement, tonnes	
			Mastheadrigg	Partialrigg	Mastheadrigg	Partialrigg
104S	4	-	6.5	8	1.4	1.7
	5	-	10	14.5	2.1	3
	6	-	17	22	3.5	4
204S	6	-8 (5.7)	19	23	3.9	4.5
	7	-10 (6.4)	27	34	5.5	7
	8	-12 (7.1) -15 (7.5)	37	45	7.5	9
304S	8	-12 (7.1) -15 (7.5)	40	50	8	10
	10	-17 (8.4) -22 (9.5)	70	80	14	15
	14	-40 (12.7)	180	190	28	30

Bushings for Navtec, BSI and OYS rods are available from Seldén. See page 101.
Furlex is available with compact wire. Just add "C" to the article number, for example 035-025-51C.

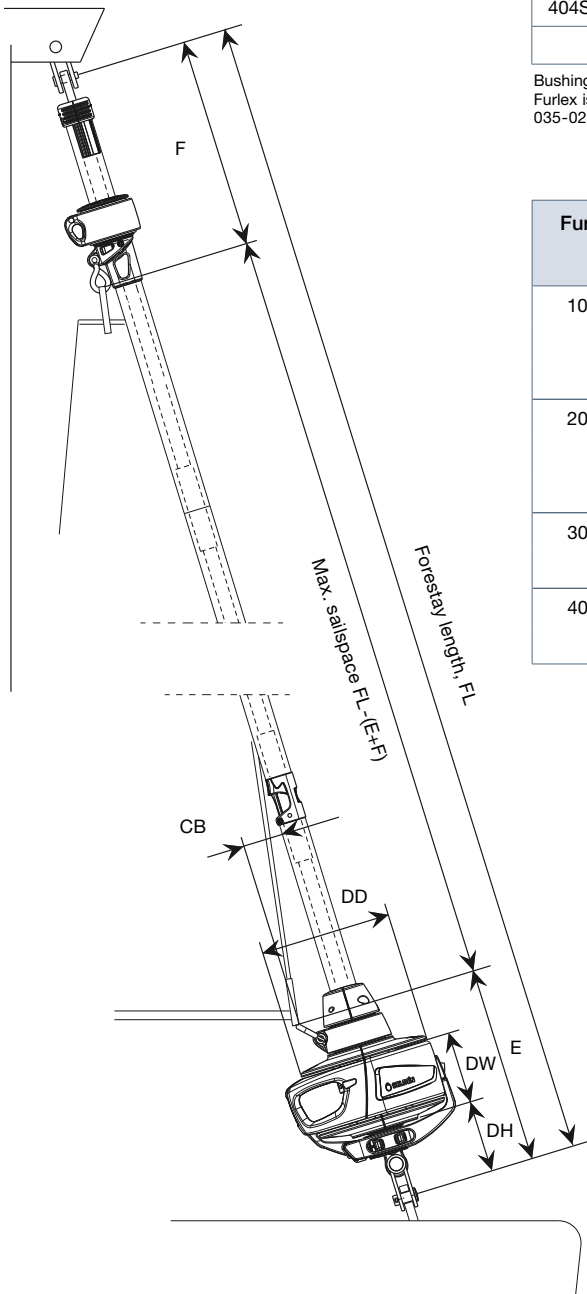

Furlex	Forestay dia. mm	DH mm	DW mm	DD mm	CB mm	E mm	F mm	ID mm	W2 mm	D2 Clevis pin	Forestay adjustment dia., mm
104S	4	85	65	155	60	205	410	17	8.5	8	60
	5	90	65	155	60	205	410	19	11	10	60
	6	100	65	155	60	220	425	24	11	10	60
204S	6	115	90	185	60	265	425	24	11	10	60
	7	115	90	185	60	265	425	24	12.5	12	60
	8	115	90	185	60	275	425	31	15.5	14	60
304S	8	125	105	220	60	310	430	31	15.5	14	80
	10	125	105	220	60	315	530	34	16	16	80
404S	12	170	135	205	80	390	630	40	21	19	100
	14	188	135	205	80	410	630	50	23	22	100

Furlex	Internal diameter of luff groove (DLG), Ø mm	Width of luff groove (WLG), mm
104S	6.0	2.75
204S	6.0	3.0
304S	7.0	3.0
404S	8.0	3.0

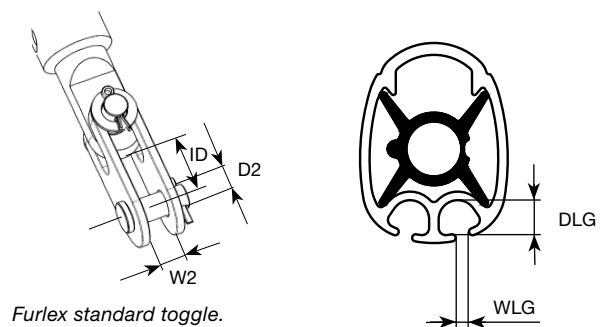

Furlex standard toggle.



 **SELDÉN**

Toggles

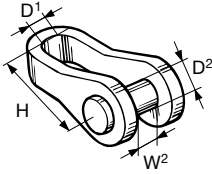
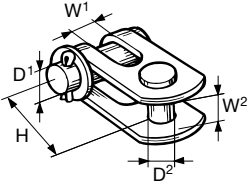
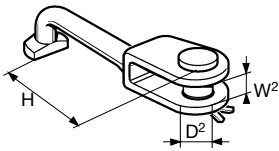
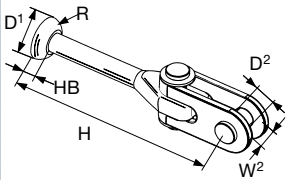
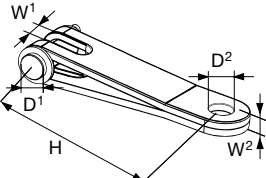
Eye/fork toggle	Forestay dia., mm	Art. No.	Length H mm	Ø Clevis pin D ² mm	Fork width W ² mm	Ø Eye D ¹ mm	For rigging screw diam	
 <p>Can be used to lengthen a Furlex system. Fit it underneath the standard fork/fork toggle or at the top end of the Furlex wire.</p>	3	174-101-01	21	6.5	7	7	1/4"	
	3, 4	174-102-01	26	8	8	8	5/16"	
	5	174-103-01	33	9.5	10	10	3/8"	
	6	174-104-01	39	11	12	12	7/16"	
	7	174-105-01	43.5	13	14	14	1/2"	
	8	174-106-01	49.5	15.8	16	16	5/8"	
	10	174-107-01	65	15.8	22	16	3/4"	
		174-132-01	65	19	22	16	3/4"	
	12	174-125-01	95	19	22	20	7/8"	
		174-134-01	91	19	22	22.5	7/8"	
	14	174-133-01	95	22	22	23	7/8"	
	174-135-01	91	22	22	23	7/8"		
16	174-126-01	120	22	25	23	M24		
Standard Furlex fork/fork toggle	Forestay dia., mm	Art. No.	Length H mm	Ø Clevis pin D ¹ mm	Ø Clevis pin D ² mm	Fork width W ¹ mm	Fork width W ² mm	
	4	517-056-02	25	8	8	7.5	8.5	
	5	517-054-02	30	10	10	10	11	
	6	517-046-02	40	12	10	11	11	
	7	517-047-02	40	12	12	11	12.5	
	8	517-048-02	50	14	14	14	12.5	
	10	517-060-04	55	16	16	14	16	
	12	517-052-02	65	19	19	20.5	21	
	14	517-053-02	80	22	22	20.5	23	
16	517-074-02	85	25	22	22	26		
T/fork toggle	Forestay dia., mm	Art. No.	Length H mm	Ø Clevis pin D ² mm	Fork width W ² mm			
 <p>Needed to connect the Furlex to a Seldén backing plate for T-terminals.</p>	4	174-127-01	68	8	8			
	5	174-128-01	80	9.5	10			
	6	174-122-01	93	11	12			
	7	174-123-01	100	13	14			
	8	174-124-01	112	15.8	16			
Stemball/eye toggle with fork/fork toggle	Forestay dia., mm	Art. No.	Length H mm	Ø Clevis pin D ² mm	Fork width W ² mm	Height HB mm	Radius R mm	Ø Stemball D ¹ mm
 <p>Needed when fitting Furlex to some masts of other origin than Seldén.</p>	5	517-065-01	138	10	11	8.5	10	26
	6	517-066-01	152	10	11	8	10	26
	7	517-097-01	153	12	12.5	11	13	26
	8	517-068-01	197	14	15.5	9	15	34
	10	517-068-02	202	16	16	9	15	34
	12	517-069-01	226	19	21	8.5	15	34
Eye/fork extension link*	Forestay dia., mm	Art. No.	Length H mm	Ø Clevis pin D ¹ mm	Fork width W ¹ mm	Ø Eye D ² mm	Gauge W ² mm	
	4	517-944-01	90	8	7	8	4	
	5	517-945-01	90	10	9.5	10	4	
	6/7	517-063-01	90	12	11	12	6	
	8/10	517-062-01	130	16	14	16.5	10	
	12	517-075-01	190	19	20.5	20	12	
	14	517-076-01	190	22	20.5	22.5	16	

* If the boat is fitted with a bow anchor, it may be necessary to permanently raise the lower bearing assembly for anchor clearance. A selection of extension links are available. If the lower bearing assembly is raised by means of an extension link, a Furlex fork/fork toggle, should be fitted between the link and the forestay attachment. This in order to secure proper articulation in all directions.

Furlex 204S-404S with rod forestay

Bush packs and join sleeve kits

Bush packs for Navtec, BSI and OYS rods are available from Seldén. Your rod rig manufacturer will supply the rod forestay and upper terminal parts, slide on rod bushing and hole screw, and form your rod heads. In some cases, the rod rig manufacturer also needs to slide on the join sleeves before forming the rod heads.

Bush packs include a bushing and a hole screw. Always needed for rod installation.

Join sleeve kits are only needed for some combinations.

Rod	Diameter mm	Type of Furlex	Bush pack	Join sleeve kit
Navtec -8	5.7	204S	301-407-42	-
Navtec -10	6.4	204S	301-408-42	-
Navtec -12	7.1	204S/304S	301-409-42	-
Navtec -17	8.4	304S	301-413-42	-
Navtec -22	9.5	304S	301-410-42	-
Navtec -30	11.1	404S	301-411-42	549-434-01
Navtec -40	12.7	404S	301-412-42	549-434-01
OYS R-8	5.7	204S	301-401-42	-
OYS R-10	6.4	204S	301-402-42	-
OYS R-15	7.5	204S	301-403-42	549-234-01
		304S	301-403-42	549-334-01
OYS R-17	8.4	304S	301-423-42	549-334-01
OYS R-22	9.5	304S	301-404-42	549-334-01
OYS R-30	11.1	404S	301-405-42	549-434-01
OYS R-40	12.7	404S	301-406-42	549-434-01
BSI -8	5.7	204S	301-418-42	-
BSI -10	6.4	204S	301-419-42	-
BSI -12	7.1	204S/304S	301-415-42	-
BSI -15	7.5	204S/304S	301-420-42	-
BSI -17	8.4	304S	301-417-42	-
BSI -22	9.5	304S	301-721-42	549-334-01
BSI -30	11.1	404S	301-422-42	549-434-01
BSI -40	12.7	404S	301-416-42	549-434-01

All Furlex systems include slotted distance tubes to be snapped on to the headed rod.

For more information on installations of Furlex for rod forestay, see instruction of assembly Art. No. 597-180-E, www.seldenmast.com.

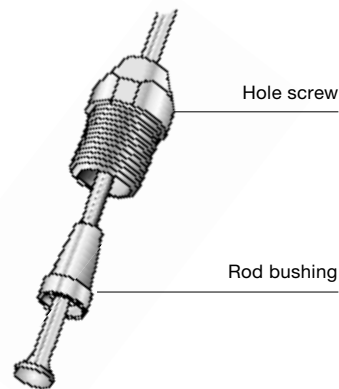



Maximise your boat's potential and let the Furlex system work without being seen.

Tacking the sail at deck level allows for a longer luff length of your foresail. You will improve sailing performance without compromising the convenience of the jib furling system. The bow will also be less cluttered as the line drum is hidden below the deck.

The free turn of the tack swivel is the same as in all other Furlex models; a necessity to reduce the furling resistance and to flatten out a reefed genoa.

The MkII version of Furlex TD (Through Deck) has all the benefits developed for the standard 4th generation Furlex, such as, smooth furling with roller bearings combined with stainless ball bearings for the drum and an optional rigging screw to adjust the forestay length. In addition, the outside diameter of the line drum is smaller than on earlier TD models which simplifies installation in narrow anchor boxes and allows for installation further forward.

Furlex TD (Through-Deck)

Optional rigging screw

204TD: 60 mm

304TD: 80 mm

Stainless torque tube

Tack attachment with free turn for reduced initial furling resistance and a flatter reefed sail.

Gimbal joint at low position for improved furling

Composite through deck fitting

Deck bearing

Small outer diameter of the drum

Adjustable fork terminal

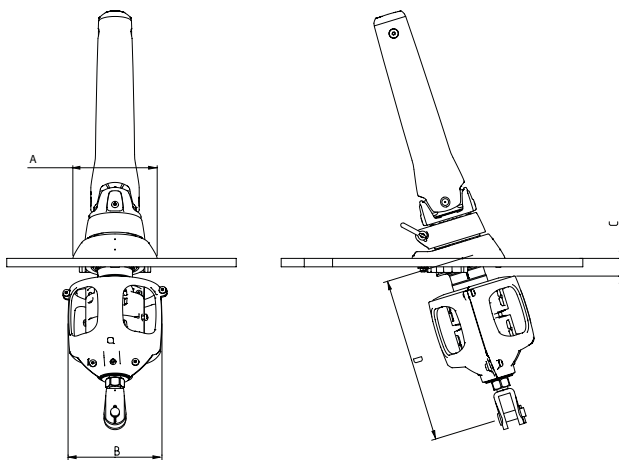

Type	A	B	C	D
204TD	126	147	22	250-415
304TD	150	167	31	300-500

Type	Forestay dimension, mm	Max. forestay length (mm)*	Standard Sta-lok terminal Art. No**	Sta-lok terminal & rigging screw Art. No**	Stud terminal for swaging Art. No**
204TD	6	10500	035-025-31	035-025-39	035-025-15
	6	12900	035-025-32	035-025-40	035-025-16
	6	15300	035-025-33	035-025-41	035-025-17
	7	12900	035-025-34	035-025-42	035-025-18
	7	15300	035-025-35	035-025-43	035-025-19
	7	17700	035-025-36	035-025-44	035-025-20
	8	15300	035-025-37	035-025-45	035-025-21
	8	17700	035-025-38	035-025-46	035-025-22
304TD	8	15260	042-031-41	042-031-46	042-031-89
	8	17660	042-031-42	042-031-47	042-031-90
	10	15260	042-031-43	042-031-48	042-031-96
	10	17660	042-031-44	042-031-49	042-031-97
	10	20060	042-031-45	042-031-50	042-031-98



Two speed function

Press one button and you will run the sail, in or out, at low speed. To double the speed, press the other button simultaneously.

All the power you need

Furlex Electric is available as a complete kit or as an upgrade kit for an existing Furlex 200S, 300S, 400S 204S, 304S and 404S series. The push-button function of a Furlex Electric makes pulling on the furling line a thing of the past.

Reliable function

Furlex Electric is designed around a highly efficient 48V electric motor. A DC/DC converter is included and converts the boat's 12V or 24V to 48V which allows for thin cables to the motor unit, easy installation and a compact unit design. Power is transmitted to a self-locking worm gear to rotate the luff extrusion at a max torque of 60Nm (204E) and 90Nm (304E). These high torque levels mean that you can always rely on being able to furl your foresail – even when the wind and sea are doing their worst.

The motor uses only 10-25 amps at normal load and it takes 25-30 seconds to furl a genoa. When sailing with a partly reefed genoa, the worm drive provides a mechanical lock. In order to prevent accidental overloading, the system comes with a built-in current limiter adapted to the type of Furlex, 204E or 304E. If you attempt to furl the sail without first releasing the sheet, the torque is immediately limited to a safe level. This safety feature is automatically re-set a few seconds after the control switch is released.

In the event of power failure, the sail is simple to furl manually. An emergency line-driver system is included as standard and can be used for both on-deck and through-deck installations. An emergency handle with ½" socket is available as an option.

On the technical side

The 48V brushless motor connects to a gear box and a steel/bronze worm gear, transmitting the torque to the luff extrusion with a gear ratio of 122:1 (emergency furling 40:1). The motor and primary gear box are packed in oil in a hermetically sealed inner compartment and all units are pressure tested during assembly. This makes for a compact design, a highly efficient transmission and a failsafe function. Nothing is left aside.



On-deck or through-deck.

The choice is yours

Furlex Electric is available for either on-deck or through-deck installations. The main advantage of a through-deck installation is better sailing performance as a result of a longer luff length. More space on the foredeck is an added bonus!



Upgrade your manual Furlex 200S – 400S (1997-2014)

Push-button performance is an easy upgrade for anyone who already has a manual Furlex 200S or 300S series (production year 1997-2015) or the current models 204S or 304S on their yacht. The furling line, drum and line guard assembly are simply replaced with a Furlex Electric motor unit. No sail conversion is required as the luff length of your existing sail is unaffected.



Converting Furlex 204S-404S to Furlex Electric



Heavy-duty toggle to withstand torsional loads. An extension link is available to provide anchor clearance.



In case of power failure, Furlex Electric can be operated manually.

Weather proof composite outer shell for rugged reliability and long service life.



Furlex Electric specifications

Type	Forestay diameter mm	L mm	HW mm	W2 mm	D2 diam. mm	H2 mm
204E	6	180	175	12	10,5	-16
	7	180	175	14	12,5	-16
	8	183	175	14	14,5	-7
304E	8	192	175	14	14,5	23
	10	191	175	16	16,5	21,5

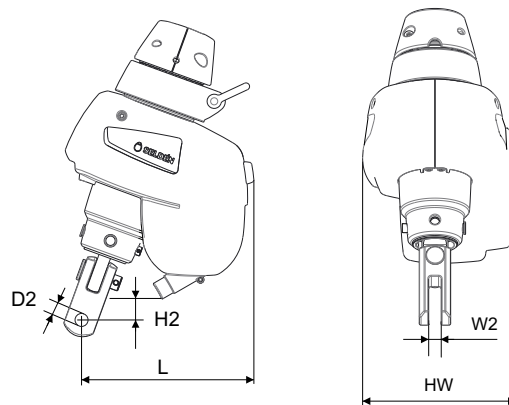

Furlex Electric assemblies (excl. control pack)

Type	Forestay diameter mm	Max. forestay length, mm	Wire termination, three options						Control pack
			Standard Sta-lok wire terminal,	Rigging screw and Sta-lok wire terminal,	Swaged terminal,	TDE version (Through-Deck) with Sta-lok,	TDE version (Through-Deck) with rigging screw,	Swaged terminal,	
			Art. No. 12V/24	Art. No. 12V/24	Art. No. 12V/24	Art. No. 12V/24	Art. No. 12V/24	Art. No. 12V/24	
204E	6	10600	035-025-101	035-025-111	035-025-121	035-025-131	035-025-141	035-025-151	For Genoa: 532-815-90
	6	13000	035-025-102	035-025-112	035-025-122	035-025-132	035-025-142	035-025-152	
	6	15400	035-025-103	035-025-113	035-025-123	035-025-133	035-025-143	035-025-153	
	For Cutter 532-815-91	7	13000	035-025-104	035-025-114	035-025-124	035-025-134	035-025-144	035-025-154
		7	15400	035-025-105	035-025-115	035-025-125	035-025-135	035-025-145	035-025-155
		7	17800	035-025-106	035-025-116	035-025-126	035-025-136	035-025-146	035-025-156
		8	15400	035-025-107	035-025-117	035-025-127	035-025-137	035-025-147	035-025-157
		8	17800	035-025-108	035-025-118	035-025-128	035-025-138	035-025-148	035-025-158
304E	8	15500	042-031-101	042-031-111	042-031-121	042-031-131	042-031-141	042-031-151	For Genoa: 532-815-92
	8	17900	042-031-102	042-031-112	042-031-122	042-031-132	042-031-142	042-031-152	
	For Cutter 532-815-93	10	15500	042-031-103	042-031-113	042-031-123	042-031-133	042-031-143	042-031-153
		10	17900	042-031-104	042-031-114	042-031-124	042-031-134	042-031-144	042-031-154
		10	20300	042-031-105	042-031-115	042-031-125	042-031-135	042-031-145	042-031-155

Control pack includes:

Motor Control Unit, Connection Box, Control Buttons, Connection cables.

Additional parts needed for the Seldén Power Supply and SEL-Bus system are listed in 597-283-E Order guide.

Type	Forestay diameter mm	Retro-fit installation kit excl. control pack		Control pack Art. No.
		Type S → E Art. No. 12V/24V	Type TD → TDE Art. No. 12V/24V	
200	6	549-601-200	549-601-225	For Genoa: 532-815-90
	7	549-601-205	549-601-225	
	8	549-601-210	549-601-225	For Cutter 532-815-91
204	6	549-601-250	549-601-275	
	7	549-601-255	549-601-275	
	8	549-601-260	549-601-275	
300	8	549-601-215	549-601-240	For Genoa: 532-815-92
	10	549-601-220	549-601-240	
304	8	549-601-265	549-601-290	For Cutter 532-815-93
	10	549-601-270	549-601-290	

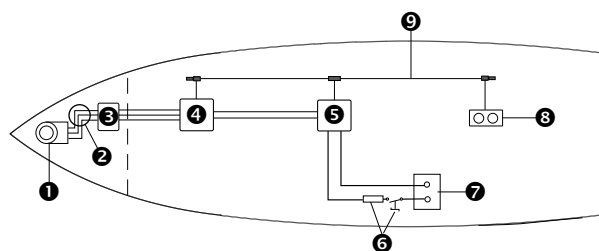

1. Furlex Electric
2. Deck gland
3. Connecting box
4. Motor control unit
5. Power supply unit
6. Main switch/fuse
7. Battery 12/24V
8. Control buttons
9. SEL-Bus system

Optional items	Art. No.
Emergency handle (1/2" socket)	533-922
Ø6/7 mm eye/fork extension link, L=90 mm	517-115-01
Ø8/10 mm eye/fork extension link, L=130 mm	517-116-01

For further technical information, please see our instructions for installation, www.seldenmast.com



Watch our furlers in action!



Seldén CX
For Code 0



Seldén GX
For asymmetric spinnakers

SELDÉN CX AND GX

Furling systems for Code 0 and asymmetric spinnakers



Sail definitions	110
The furlers	111
Accessories	114

Seldén CX and GX



Want to see your crew smile?

The power and acceleration achieved when unfurling a Code 0 or an asymmetric spinnaker is spectacular. It will make your sailing more fun.

Simply hoist the furled sail, release the furling line, pull on the sheet and you have added horse power to your sailing and given your crew a positive sailing experience. To douse the sail, ease the sheet, pull the continuous furling line and secure it in the purpose made Twin Cam block. Once the sail is furled it can be neatly dropped and coiled into a bag or left hoisted for later use. Seldén provide all necessary accessories for safe and carefree furling of “off-the-wind” sails.

The sails

Code 0

The Volvo Ocean Race was the breakthrough for the Code 0 concept, but lately the benefits of this type of sail have become recognized and appreciated also amongst ordinary sailors for the extra power it brings to light wind sailing. The luff is straight, set under tension and made for furling which simplifies the handling of this large sail. An AT-cable is integrated in the luff and fitted with thimbles in head and tack, and the entire luff length is furled simultaneously. The Code 0 is hoisted as high as the mast dimension permits and is tacked to the bow or to a sturdy bowsprit. The design is quite flat and reaches its maximum performance in apparent wind angles between 40° and 90°. Seldén CX is the right furler for this sail.

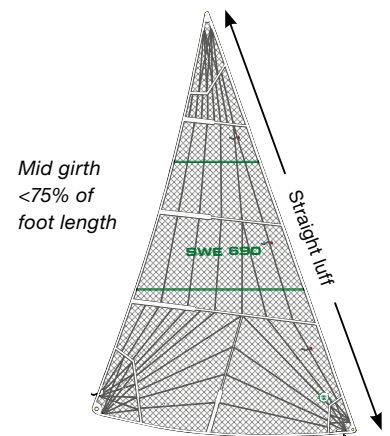

Asymmetric spinnaker

This sail is often called “gennaker” or “cruising chute”. The mid girth is >75% of the foot length and the sail is defined as a spinnaker in most international measurement rules. The luff is at least 2% longer than the leech and this is what makes the sail asymmetric. This sail is furled with a Seldén GX system and fitted at the tack to the swiveling tack attachment and at the head to the halyard swivel. An AT-cable connects the drum and the halyard swivel and transmits the rotation of the drum enabling the furling to start at the top and work its way down until the entire sail is stowed away. This is called top-down furling. The Seldén GX furler is fitted to the bow of the boat or preferably on a retractable Seldén bow sprit to expose the sail to the wind and to get clearance from the forestay. The halyard tension is moderate and the sail is hoisted using the spinnaker halyard. This sail performs at its best in apparent wind angles between 70° and 110°.

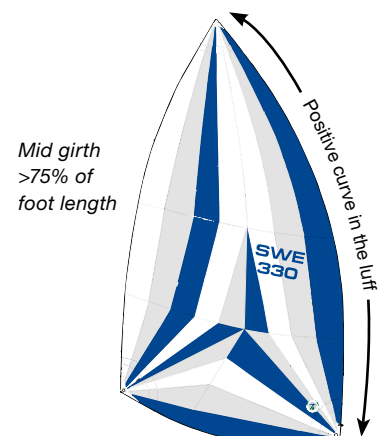

The furlers

Seldén CX and Seldén GX are operated with an endless furling line running over a line driver drum. The furling line is preferably led all the way back to the cock pit and Seldén offer the Double Fairlead and the Twin-Cam block for a well organized set up. A purpose made AT-cable has been developed to secure the function of the system and as the performance of top-down furling is dependant on the torsional rigidity of the AT-cable, it is included in the Seldén GX furlers.

- Metal "teeth" in the drum make for a good grip on the line when furling the sail.
- A wedge in the line guide separates the line from the drum when unfurling the sail and the drum spins freely.
- Sealed steel bearing in the drum and in the halyard swivel for long service life.
- Rubber fender prevents the halyard swivel from chafing the mast while hoisting the furled sail.
- CX. Spring loaded lock makes it easy to connect the thimbles to the drum and the halyard swivel.
- GX. Patented line lock for easy mounting of the AT-cable to the drum and to the halyard swivel.
- All structural parts are made of high-strength Duplex stainless steel. This means reduced material and low weight.
- Non-structural parts are made of impact resistant glass fibre reinforced polyamide composite.

Seldén GX, for top-down furling of an asymmetric spinnaker/gennaker

Seldén GX drum and halyard swivel and an AT-cable is included in the kit. The drum and the halyard swivel are permanently fitted to the sail with the Seldén line lock. Connect the drum to the bow and the spinnaker halyard to the halyard swivel. Lead the furling line to the cockpit by using Seldén Double Fairleads on the stanchions, tighten the furling line and secure it in the Twin-Cam block. Thereafter hoist the furled sail.

Seldén GX	Kit including GX drum, halyard swivel and AT-Cable Art. No. 1 + 2 + 3	Max length of the system	Drum size, Ø mm	Dimension of included AT-cable, Ø mm	Max suggested sail area m ²	Max working load, kN
GX7.5	545-018-21	13000	105	9	50	7.5
	545-018-22	16000				
	545-018-23	19000				
GX10	545-118-21	13000	120	11	80	10
	545-118-22	16000				
	545-118-23	19000				
	545-118-24	22000				
GX15	545-218-21	16000	150	13	115	15
	545-218-22	19000				
	545-218-23	22000				
	545-218-24	25000				
	545-218-25	28000				
GX25	545-418-21	19000	190	15	200	25
	545-418-22	22000				
	545-418-23	25000				
	545-418-24	28000				



Seldén CX, for Code 0

The AT-cable is integrated in the luff of the sail and thimbles connect the luff to the drum and to the halyard swivel. Special cable clamps are required to fit the thimbles to the Seldén AT-cable. A dedicated halyard for Code 0 is required and 2:1 purchase is recommended to obtain the required luff tension and to reduce the load on the halyard sheave and on the line stoppers. The drum and the furling line can be permanently mounted to the bow and along the stanchions.

Seldén CX	Kit including drum and halyard swivel Art. No. ①+②	Drum size, Ø mm	Safe working load, kN	Max suggested sail area, m ²	Max RM at 30° heel, kNm	Approx. displacement, tonnes
CX10	545-010-10	105	10	50	25	5
CX15	545-100-10	120	15	80	45	7,7
CX25	545-200-10	150	25	115	90	14
CX45	545-433-10	190	45	200	200	28



A Seldén CX15 Code 0 furler and a Race80 Bowsprit from Båtsystem, Sweden. www.batsystem.se. The luff load on a Code 0 is more than the double compared to an asymmetric spinnaker. Therefore, a sturdy bowsprit is required.

Seldén CX, for top-down furling of an asymmetric spinnaker/gennaker

This is an alternative to GX allowing the drum and the furling line to be mounted permanently. Snap in the furling gennaker and hoist it using the spinnaker/gennaker halyard.

A Seldén CX drum is combined with a Free Tack Adapter and a GX halyard swivel, both of them with Seldén line lock. The furling sail with the Adapter is connected to the drum and the sail is hoisted with the spinnaker halyard. The drum and the furling line can be permanently mounted to the bow and along the stanchions.

Seldén CX	CX drum Art. No. 2	Kit including Free Tack Adapter & GX halyard swivel Art. No. 1 + 3	AT-cable Dimension, Ø mm	This combination equals...	Max suggested sail area, m ²
CX10	545-010-11	545-028-10	9	GX7.5	50
CX15	545-100-11	545-128-10	11	GX10	80
CX25	545-200-11	545-228-10	13	GX15	115
CX45	545-433-11	545-428-10	15	GX25	200



Seldén CX, for Code 0 & top-down furling of an asymmetric spinnaker/gennaker

This is an all-in-one solution for the sailor using both Code 0 and gennaker and prefers using one halyard for both applications.

A Seldén CX drum and halyard swivel for thimbles are used both for the Code 0 sail and an additional gennaker. Connect the sail suitable for the prevailing conditions to the drum and to the halyard swivel and hoist the furling sail using the Code 0 halyard. The Free Tack Adapter is permanently fitted to the tack of the asymmetric spinnaker/gennaker with the Seldén line lock. The drum and the furling line can be permanently mounted to the bow and along the stanchions.

Seldén CX	CX drum and halyard swivel Art. No. 1 + 2	Adapter Art. No. 3	AT-cable Dimension, Ø mm	This combination equals...	Max suggested sail area of the gennaker, m ²
CX10	545-010-10	545-028-11	9	GX7.5	50
CX15	545-100-10	545-128-11	11	GX10	80
CX25	545-200-10	545-228-11	13	GX15	115
CX45	545-433-10	545-428-11	15	GX25	200



Accessories

Seldén AT-cables (Anti-Torsion)

The more torsional rigid AT-cable, the quicker and safer the sail will furl.

Seldén provide the most rigid cable on the market, three times more rigid than the second best, and it is included in the Seldén GX kit.

Art. No.	Length, mm	Dimension, Ø mm	To be used for...
613-020-01 613-020-02 613-020-03	13000 16000 19000	9	CX10 CX15 GX7,5 CX10 + GX7,5 adapter
613-021-01 613-021-02 613-021-03 613-021-04	13000 16000 19000 22000	11	CX10 CX15 CX15 + GX10 adapter GX10
613-022-01 613-022-02 613-022-03 613-022-04 613-022-05	16000 19000 22000 25000 28000	13	GX15 CX25 CX25 + GX15 adapter
613-023-01 613-023-02 613-023-03 613-023-04	19000 22000 25000 28000	15	CX45 GX25 CX45 + GX25 adapter

Unique and patented line lock system



Line terminal with a conical shape. Set of wedges.



Pull the terminal over the line and fold the core of the line over the wedges. Insert the wedges to the terminal.



Install the drum/halyard swivel and tighten the locking screw.

Endless furling line

Art. No. Line only	Art. No. Line with Twin cam block installed	Length, mm	Dimension, Ø mm	To be used for...
611-007-06 611-007-07 611-007-09 611-007-08	611-007-31 611-007-32 611-007-33 611-007-34	2 x 4000 2 x 8000 2 x 10000 2 x 12000	8	CX10 CX15 GX7,5 GX10
611-011-05 611-011-06 611-011-07 611-011-18 611-011-19	611-011-31 611-011-32 611-011-33 611-011-34 611-011-35	2 x 5000 2 x 7000 2 x 9000 2 x 12000 2 x 15000	10	CX25 GX15
611-015-06 611-015-07 611-015-08 611-015-09	611-015-31 611-015-32 611-015-33 611-015-34	2 x 5000 2 x 9000 2 x 12000 2 x 17000	12	CX45 GX25



Twin cam block for furling line
PBB50 Art. No. 405-001-40R
(max Ø10 mm line)
PBB60 Art. No. 406-001-40R
(Ø12 mm line)

Double Fairlead

Ordinary blocks cannot be used to lead the endless furling line back to the cockpit. Seldén Double Fairlead consist of a composite bracket fitted to a 25 mm or 30 mm stanchion and a spring loaded "push-and-twist" bracket in stainless steel. Easy to open to attach the line and just as easy to close. The Double Fairlead prevents the line to get tangled up and the smooth stainless bracket prevents friction. Art. No. 480-501-01R.



Code 0 halyard with 2:1 purchase

To boost the performance when using a Code 0, the halyard load must be higher than what normal halyard boxes and stoppers can handle. Therefore, a 2:1 purchase needs to be arranged by fixing the dead end of the halyard in the mast and letting it run through a block attached to the halyard swivel. Position on the mast must be specified by Seldén. In most cases Code 0 sails need to be hoisted lower than gennakers and spinnakers.



Block for 2:1 purchase

Art. No.	Dim.	Weight, g	L ¹	L ²	W	D	Safe working load, kg	Breaking load, kg	Max line size, mm	To be used for...
403-501-01R	30	130	66	21	13	8	1500	3000	10	CX15
404-501-01R	40	245	83	26	18	10	2500	5000	12	CX25, GX25
405-501-01R	50	505	104	31	24	12	4000	8000	16	CX45

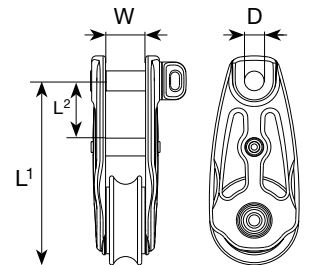

Dead end fitting

Art. No.	Mast section	Max rope, Ø mm	Max RM at 30° heel, kNm
508-843-01R	C156-F228	12	45
508-844-01R	C245-F305	14	180
508-838-01R	C321-F406	16	350



Thimbles for AT-cable

Art. No. (2 pcs)	For AT-Cable, Ø mm	To be used for...
545-114-01	8-9	CX10, CX15
545-116-01	10-11	CX10, CX15
545-216-01	12-13	CX25
545-416-01	14-16	CX45



Cable clamps

To fit thimbles to the Seldén AT-cable. Heat shrink tubing included.

Art. No. (2 pcs)	For AT-Cable, Ø mm
301-311-01	9-11
301-312-01	12-13
301-313-01	14-15



For CX25 and CX45 double clamps at each end of the AT-cable are required.

Adapters

An adapter adds a tack swivel to a CX furler. The CX drum can now be used both for Code 0 and for asymmetric spinnaker/gennaker. The adapters feature the patented Seldén line lock and Torlon ball bearings.

Art. No.	Converts...	...to
545-028-11	CX10	GX7.5
545-128-11	CX15	GX10
545-228-11	CX25	GX15
545-428-11	CX45	GX 25



Anti-Twist shackle

The Anti-Twist shackle is an optional shackle connecting the halyard to the halyard swivel. The long pin will lean against the mast and prevent a “soft” halyard from twisting.

This shackle is not necessary for a 2:1 halyard set up nor is it for a high quality Dyneema® halyard.

Art. No.	Dimension	To be used for..
545-030-01R	M6, L = 220 mm	CX10, GX7.5, GX10
545-130-01R	M8, L = 220 mm	CX15, GX15
545-230-01R	M10, L = 280 mm	CX25, GX25
545-430-01R	M12, L = 390 mm	CX45



Low friction shackle

This snap shackel has a big, well rounded loop allowing the rope to slide with low friction and it can be used to tension a Seldén CX with 2:1 purchase. This not only makes for better performance but it also makes it easier to connect the Seldén CX to a bowsprit, from the fore-deck. The shackle is made of high strength Duplex steel and has a quality mirror finish.

Art. No.	Dimension	Weight, g	Safe working load, kg	Breaking load, kg	To be used for...
307-435-01R	50	70	900	1800	CX10, GX7.5, GX10
307-436-01R	60	118	1500	3000	CX15, GX15
307-437-01R	80	278	2500	5000	CX25, GX25
307-438-01R	100	540	4000	8000	CX45

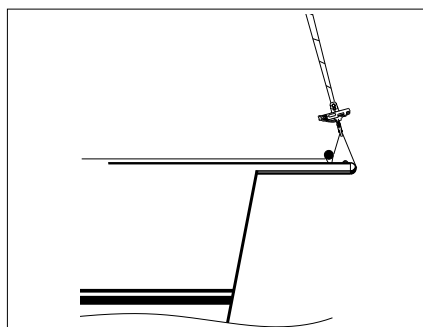
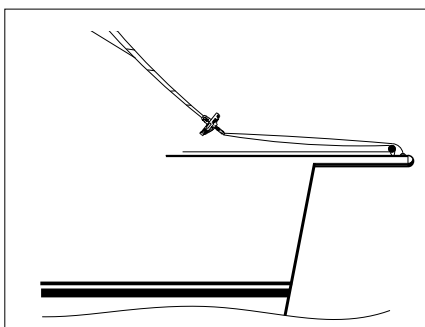

Adjustable Tack Swivel (ATS)

This accessory for Seldén GX furlers enables the sailor to easily trim the luff of the asymmetric spinnaker/gennaker. The Adjustable Tack Swivel slides up and down over the AT-cable and is handled from the cockpit with a down haul. As opposed to trimming the luff by slacking the halyard, the AT-cable can now be permanently tensioned and always ready for furling.

Art. No.	To be used for...
545-040-10	GX7.5
545-140-10	GX10
545-240-10	GX15
545-440-10	GX25

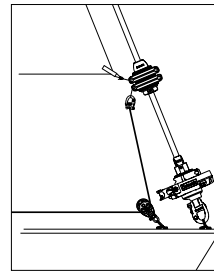

The sliding sleeve of ATS consists of two halves and therefore it is easy to retrofit the swivel to a GX furler.

Bracket for masthead rigs

To allow for a Seldén GX system to be fitted to a mast head rig, the halyard must be moved forward to prevent conflict between the halyard swivel and the forestay.

A mast head bracket with a smooth halyard lead solves the problem. This bracket is intended for gennakers/asymmetric spinnakers only and not Code 0's.

Max righting moment (RM) at 30° heel; 35 kNm.

Calculate your boat's RM with the calculator found on our website.



Art. nr. 508-060-01R





Hydraulics are used for efficient trim of the sails and for pure convenience.

HYDRAULICS



Mast jack system	120
The hydraulic set up	122
Furlex Hydraulic	126
Hydraulic cylinders	130

Mast jack system

A mast jack from Seldén ensures that you always retain the right rig tension for racing. It also lets you relieve the load on the rig and boat when you are in port. The mast jack system consists of a hydraulic cylinder located inside the mast. The cylinder piston moves down vertically through the heel of the mast to a steel plate in the boat's T-base, thereby lifting the mast and increasing the tension.

In order to make it easier to jack up the mast, the system includes a two-stage pump that switches to its lower gear as the pressure increases. When the mast reaches its upper position, shims are placed between the heel and the T-base. Release the pressure and remove the pump.

Now, the rig is set in accordance with the predetermined requirements. So is the boom height, I-measurement and other rating measurements recorded by the measuring official.

The pump is connected to the cylinder with stainless steel couplings, and can easily be disconnected and left ashore prior to racing. The hydraulic hose is then stored in a purpose-designed hose garage to keep it out of the way. The hose garage itself is fitted inside the mast.

The T-base has the same pattern of holes as Seldén's standard T-base, and its position can be adjusted in fore and aft direction to obtain the optimal mast rake.

The hose is stored in a hose garage...



...and can easily be fitted to the pump to adjust the rig tension.



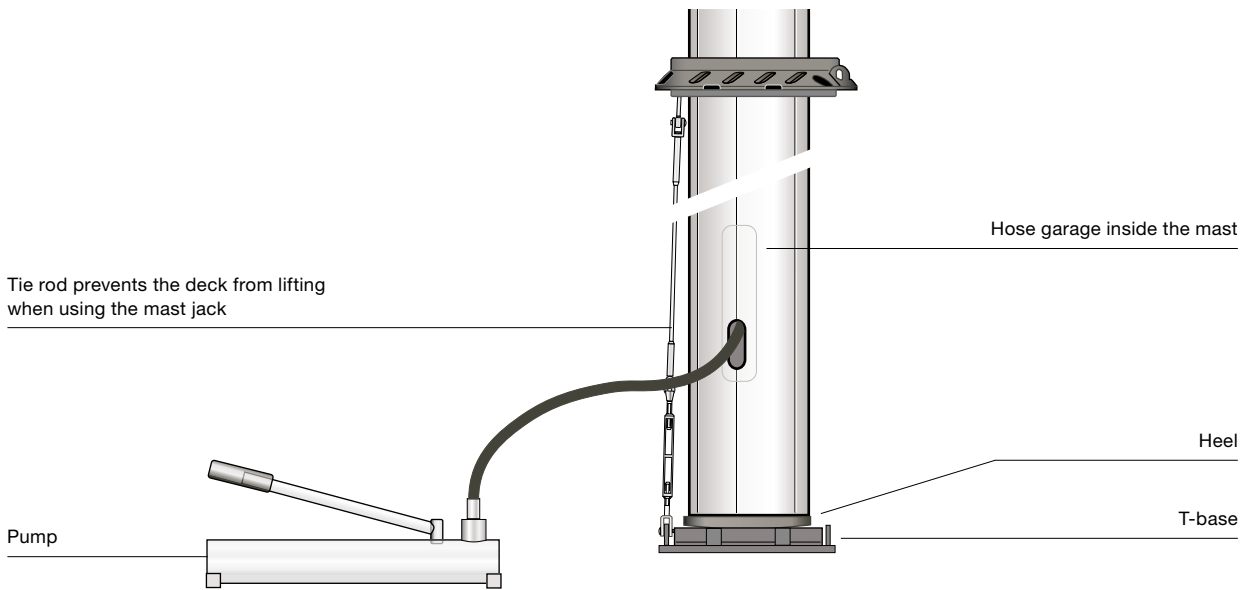

Technical specifications

System	Mast extrusion	Max pressure (bar)	Max working load (kN)
D65/300	C193 CC192	300	100
D63/400	C211-C245 CC210-CC244	400	125
D80/400	C264-C304 CC263-CC303	400	200

Mast jack cylinder fitted on mast heel and 2-metre hose with quick coupling (male)	Mast extr.	Art. No.	Mast extr.	Art. no
	Alu-minium		Carbon	
	C193	502-196-01	CC192	502-196-03
	C211	502-190-01	CC210	502-190-03
	C227	502-191-01	CC226	502-191-03
	C245	502-192-01	CC244	502-192-03
	C264	502-193-01	CC263	502-193-03
	C285	502-194-01	CC284	502-194-03
	C304	502-195-01	CC303	502-195-03

Pump with manometer	System	Art. No.
	D65/300	550-150-01
	D63/400	550-160-01
	D80/400	550-160-02

T-base with shims and U-bolts for attaching tie rod	System	Art. No. (dim., mm)
	D65/300	510-208-01 (205x140x15)
	D63/400	510-180-01 (300x125x15)
	D80/400	510-185-01 (370x160x25)

Tie rod kit, includes conversion parts for standard deck ring	Mast extrusion	Art. No.
	C193, CC192	601-003-54
	C211, C227, CC210, CC226	508-309-02
C245, CC244	508-309-03	

Accessories	Art. No.
Hose garage, including pop rivets	507-537-01
Shim, 2 mm (D65/300)	510-209
Shim, 5 mm (D65/300)	510-210
Shim, 10 mm (D65/300)	510-211
Shim, 2 mm (D63/400) (Optional)	510-214
Shim, 5 mm (D63/400)	510-181
Shim, 10 mm (D63/400)	510-182
Shim, 15 mm (D63/400)	510-183
Shim, 2 mm (D80/400) (Optional)	510-215
Shim, 5 mm (D80/400)	510-186
Shim, 10 mm (D80/400)	510-187
Shim, 20 mm (D80/400)	510-189
Locking bolts for shims (D65/300)	165-107
Locking bolts for shims (D63/400)	165-207
Locking bolts for shims (D80/400)	166-011
1/4" hydraulic hose, 2 metres, with couplings	540-965-01
Quick coupling (male)	540-966
Protective plastic cover for 540-966	540-968
Quick coupling (female)	540-967
Protective plastic cover for 540-967	540-969
Sealing washer for coupling	540-885
U-bolt for securing tie rod	508-023-02
Silicone spray, 250 ml, for rubber wedges for deck ring	312-506
Safety wire with Talurit eye. Some racing rules stipulate safety wire between mast and T-base.	508-010-10

Hydraulic cruise control



Seldén's hydraulic furling system for mainsail and foresail are:

- Furlex Hydraulic for headsails
- Hydraulic furling mast
- Hydraulic outhaul

The picture to the right shows the principle of a hydraulic system with hydraulic pump, valve units and drive units, all connected by hydraulic hosing. The system is operated from the cockpit by control switches connected to the system through a control box.

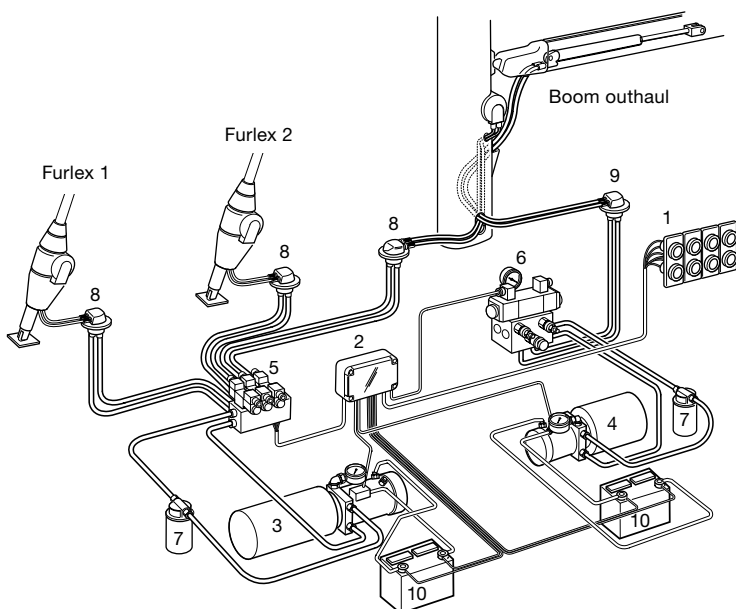

1. Control buttons
2. Control box
3. Pump unit, furling mast + Furlex
4. Pump unit, outhaul
5. Valve unit, furling mast + Furlex
6. Valve unit, outhaul
7. Filter
8. Deck gland, furling mast + Furlex
9. Deck gland, outhaul
10. Battery



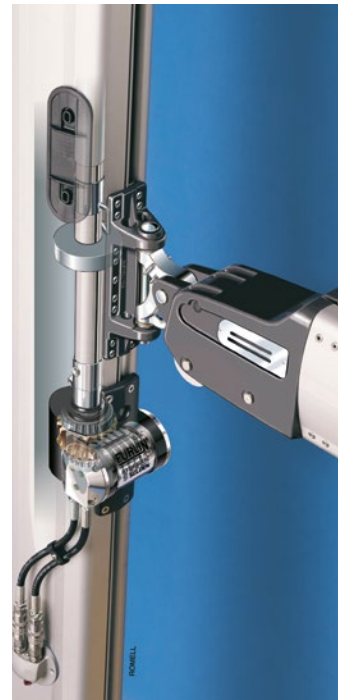

Långedrag 501 equipped with Seldén hydraulic furling mast, hydraulic outhaul and double hydraulic Furlex jib-reefing systems.

Sailing from the cockpit at the press of a button

A powered furling mast enables you to reef, furl and trim the sail area to suit the wind conditions at the touch of a button. The patented, built-in motor has a direct drive to the worm gear, to keep moving parts to a minimum and increase power, efficiency and reliability. The worm gear, which is self-braking, locks the sail in the required position. In an emergency, the mainsail can also be manually furled and unfurled with an ordinary winch handle.

Hydraulic clew outhaul – the ultimate control

The push-button controls in the cockpit give you complete command of your mainsail. You can also trim the outhaul when sailing close hauled – a task which would ordinarily require the full strength of a crew member using a manual winch. Furthermore, there is no clew outhaul line to clutter up the cockpit.

Booms available for hydraulic outhaul.

B200, B250, B290 and B380



Specifications of hydraulic motors

Model	Motor designation	Max. torque at max. pressure, Nm	Nominal speed luff extrusion (n), rpm	Nominal oil flow (Q), l/min	Nominal oil pressure (p), bar	Max. oil pressure (p), bar	Rec. min. power hydraulic pack (P) kW	Max. sail area m ²
Type RB	OML 12.5	158	40	10	40	120	1.5	60
Type RC	OML 12.5	158	40	10	40	140	2.0	60
Type RD	OML 12.5	158	40	10	40	140	3.0	80
Type RD	OML 20.0	230	40	20	40	140	4.0	120
Type RD Built-in	OML 20.0	255	40	20	40	140	3.0	120

Furlex H

(Hydraulic)



With a Furlex Hydraulic, the cruise control is complete. All you need to do is press a button in the cockpit and adjust the sheet.

The Furlex Hydraulic is designed to provide a harmonious visual interplay of stainless steel and aluminium. The hydraulic motor is located inside the worm gear, in the same way as it is with the furling mast system. The positioning of the motor contributes to the compact design of the Furlex Hydraulic.

Type	Forestay dia., mm	Max. forestay length, m	Motor designation	Art. No.				
300H	8	15.5	OML 12.5	039-027-70				
		17.9		039-027-71				
	10	15.5	OML 12.5	039-027-72				
		17.9		039-027-73				
400H	12	20.3	OML 12.5	039-027-74				
		17.7		OML 20	049-034-75			
		20.1			049-034-76			
	22.5	049-034-77						
	14	17.7	OML 12.5	OML 20	049-034-95			
		20.1			049-034-96			
		22.5			049-034-97			
		20.1			OML 12.5	OML 20	049-034-78	
		22.5					049-034-79	
		20.1					049-034-98	
22.5		049-034-99						
500H	16	23.0	OMM 20	060-046-50				
		27.8		060-046-51				
		-60 rod		060-046-70				
	-40 rod	32.6	OMM 20	OMM 20	060-046-71			
		23.0			060-046-80			
		27.8			060-046-81			
		-48 rod			23.0	OMM 20	OMM 20	060-046-90
					27.8			060-046-91
					32.6			060-046-92



Furlex Hydraulic, deck gland and deck gland protection.



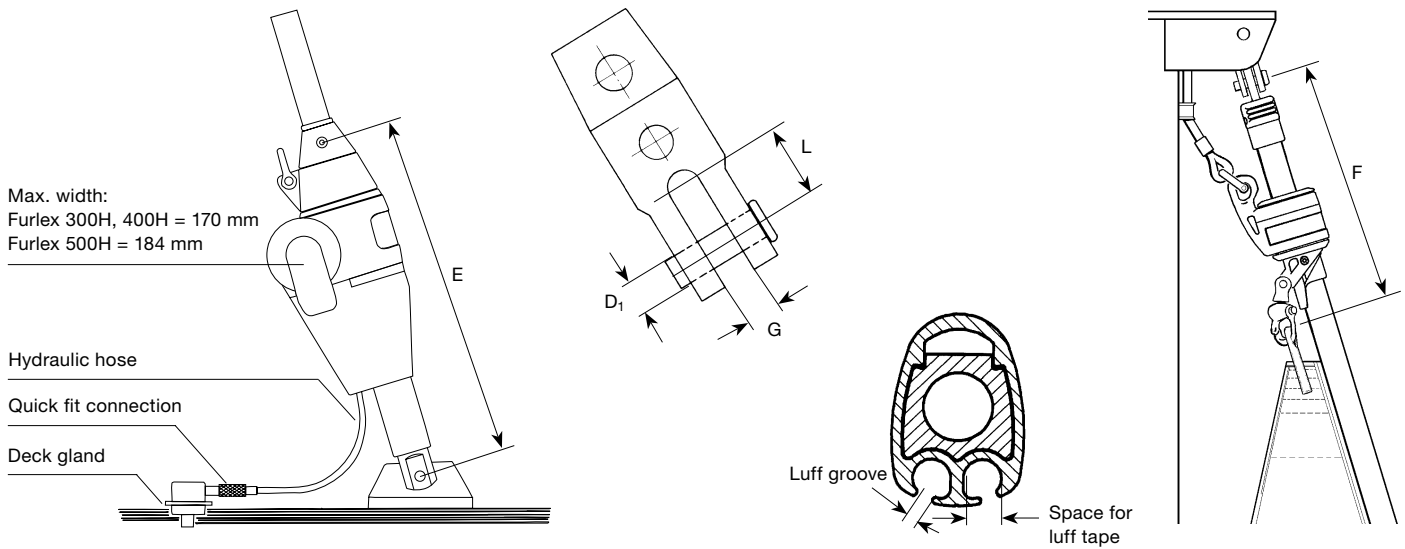

Furlex Hydraulic specifications

Type	Total weight drive unit, kg	Luff extrusion kg/m	Halyard swivel, kg	Extrusion dim., mm	Luff groove mm	Max space for luff tape, dia., mm	Max. luff tape dia., mm	"Cut-Back" mm
300H	16	0.76	1.7	40 x 27	3.0	7	6	80
400H	25	1.06	3.3	50 x 34	3.0	8	6	100
500H	37	1.93	7.0	60 x 46	3.0	9	7	100

Type	Forestay wire dia., mm	Rod dia. mm	Nav-tec	OYS* (Riggarna)	BSI	Max RM (kNm) at 30° heel		Clevis dia., mm	G mm	L mm	E mm	F mm	Forestay adjustment										
						Masthead	Fractional																
300H	8	-12 (7.1)	X		X	40	50	14	15	30	490	540	100										
		-15 (7.5)		X	X																		
	10	-17 (8.4)	X		X	70	80	16	15	30													
-22 (9.5)		X	X	X																			
400H	12	-30 (11.1)	X	X	X	120	160	19	19	35	610	620	110										
		-30 (11.1)	X																				
	14	-40 (12.7)	X	X	X	180	190	22	23	40													
-40 (12.7)		X	X	X																			
500H	16	-				230	250	25.4	26	45	675		100										
		-40 (12.7)	X	X										180	190	25.4	26	45					
		-48 (14.3)	X	X	X																		
		-48 (14.3)	X	X	X														230	250	28.6	29	50
		-60 (16.8)	X	X	X																		

* The upper eye terminal must be of the MNY type.

Type	Motor designation	Max. torque at max. pressure, Nm	Nominal speed luff extrusion (n), rpm	Nominal oil flow (Q), l/min	Nominal oil pressure (p), bar	Max. oil pressure (p), bar	Rec. min. power hydraulic, pack (P) kW	Max. sail area m ²
300H	OML 12.5	158	40	10	40	140	1.5	80
400H	OML 12.5	175	40	10	40	140	2.0	125
400H	OML 20.0	255	40	20	40	140	3.0	150
500H	OML 20.0	290	40	20	40	140	4.0	200

Hydraulic adjusters and vang

Fast and convenient adjustment of the backstay and the vang is vital both for the racing sailor and for the cruising sailor. Being able to tension the forestay, adjust the pre-bend of the mast and control the power in the mainsail will make any boat point higher, sail faster and under better control. Seldén has developed a range of hydraulic cylinders based on functional design, ease of use, reliability and long service life. The rods are marine grade stainless steel and the cylinders black anodized or clear anodized aluminium. The tensioners have long stroke making it possible to try out different mast rakes.

Hydraulic Tensioners Integral (HTI)

Hydraulic Tensioners (HT) for Seldén control panels

- A 2-speed function permits fast tensioning until a pre-set pressure is obtained. Then the tensioner shifts down to low speed and reduced resistance in the handle. The level of pressure needed to gear down is easily adjusted to suit the individual trimmer.
- Available for Ø8 – 14 mm backstay wires (equals -17 to -40 rod).
- HTI: The gauge is at the top of the tensioner making it easy to check the achieved pressure (bar).
- Releasing the pressure is done by twisting the control of the release valve.
- An adjustable relief valve prevents overload.



Hydraulic Tensioners Integral (HTI)

Hydraulic Tensioners (HT) for Seldén control panels

Hydraulic Backstay Tensioners

Art. No.	Tensioner	Anodization	Max wire size, Ø mm (rod size)	Pulling force at max working pressure, kN	Max working pressure, bar (psi)	Stroke, mm	Contracted length, mm	Lower pin diameter, Ø mm	Cylinder dia, Ø mm	Piston rod thread	Weight, kg	2-speed function	Dual Action
580-001-10	HTI-W8/10 Backstay tensioner with integral pump	Clear	10 (-17)	44	345 (5000)	420	1028	15.8	62	UNF 5/8" – 18 Left hand	8.1	Yes	No
580-002-10		Black											
580-003-10	HT-W8/10 Backstay adjuster for control panel	Clear				826	4.3	Yes					
580-004-10		Black											
580-005-10	HTI-W12/14 Backstay adjuster. integral pump	Clear	14 (-40)	85	480	1156	22	80	UNF 7/8" – 14 Left hand	13		No	
580-006-10		Black											
580-007-10	HT-W12/14 Backstay adjuster for control panel	Clear				912	8	Yes					
580-008-10		Black											

Upper terminals

Tensioner	Fork, Stainless		Upper pin diameter, Ø mm	Rigging screw body and split pin	
	Art. No.			Art. No.	
HTI-W8/10 HT-W8/10	581-415-01		15.8*	5/8"	174-326-99
HTI-W12/14 HT-W12/14	581-416-01		22	7/8"	174-328-99
	581-416-02		19		



* When W8/10 is used on a Ø7 mm backstay with Ø13 mm hole dia, a conversion kit with bushings and a Ø12 mm clevis pin is required. Art. no. 306-558-04.

Toggle

Tensioner	Art. No.	Lower pin diameter, Ø mm
HTI-W8/10 HT-W8/10	174-107-01	15.8*
HTI-W12/14 HT-W12/14	174-135-01	22
	174-134-01 (for -22 rod)	19



Art. No. 306-558-03

* If the chain plate have a Ø13 mm hole dia, an eye/fork toggle (art. no. 174-106-01) and a conversion kit (art. no. 306-558-03) including bushings and a Ø12 mm clevis pin are required.

Hydraulic boom vang (HV)

Art. No.	Description	Anodization	Pulling force at max working pressure, kN	Max working pressure, bar (psi)	Maximum return force, kN	Stroke, mm	* PCLC (Pin Center Length Closed), mm	Pin diameter, Ø mm	Cylinder dia, Ø mm	Weight, kg
580-013-10	HV-44 Boom vang	Clear	44	345 (5000)	8,4	280	2400	15,8	70	12
580-014-10		Black								
580-015-12	HV-57 Boom vang	Clear	57		12	280	2650	19	80	15,8
580-016-12		Black								
580-017-501	HV-89 Boom vang	Clear	89	25	340	2300	25	85	27	
580-018-501		Black				2300			27	
580-017-01		Clear				2790			33	
580-018-01		Black				2790			33	



Hydraulic boom vang (HV)

* Custom lengths can be made by customer request.

Control panels

- Available for single function or 4-functions.
- The panels have a Dual Action function which means the pump is active both when pushing and when pulling the handle.
- An adjustable relief valve prevents overload.
- A 2-speed function permits fast tensioning until a pre-set pressure is obtained. Then the panel shifts down to low speed and reduced resistance in the handle. The level of pressure needed to gear down is easily adjusted to suit the individual trimmer.
- The panels can be connected to an electric pump station that replaces manual pumping with the push of a button.
- The panels are black anodized or clear anodized aluminium.



Control panel, 1-function



Control panel, 4-function

Control panels

Art. No.	Number of functions	Anodization	2-speed function	Dual Action
586-500-10	1	Clear	Yes	Yes
586-501-10		Black		
586-500-14	4	Clear		
586-501-14		Black		



Pump handle, Art. No. 587-101-01 stainless steel, Ø20 x 500 mm



Oil reservoir, Art. No. 585-300-01



Electric pump, Art. No. 587-800-01

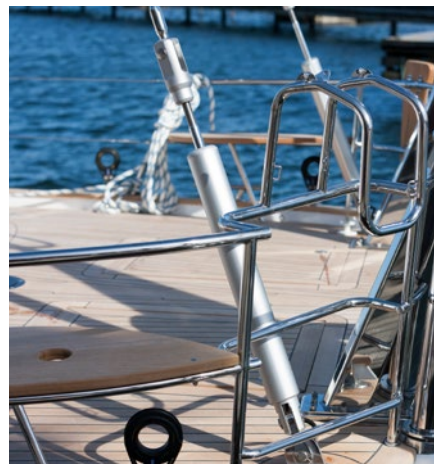



First 40 featuring a HT-W8/10 tensioner and control panels both sides in the cockpit.



HV-57 hydraulic boom vang.



The exhilarator

Once you have experienced the thrill of the wind filling the spinnaker, you are sure to be hooked on spinnaker sailing. Seldén brings this sensation to yachtsmen all over the world through its complete range of easy-to-use aluminium and carbon spinnaker poles and accessories.

SPINNAKER & GENNAKER

poles and accessories



Aluminium spinnaker poles	134
Telescopic poles	136
Jockey poles	136
Setting a spinnaker	137
Carbon spinnaker poles	138
Selecting the right pole	140
Spinnaker pole kits	144
Spinnaker halyard attachments	146
Spinnaker pole attachments	147
Spinnaker pole fittings	150
Spinnaker pole heel lift system	152
Vertical pole stowage	153
Gennaker bowsprit	154

Aluminium spinnaker poles



Seldén aluminium spinnaker poles give you fast and safe spinnaker handling. All the fittings have well-rounded edges to prevent personal injury and damage to equipment. The extrusions are lightweight and very durable, and are fitted with pole savers to shield the pole against damage from forestay and shrouds.

Composite end fittings are available for our Ø 48-Ø 96 poles. These fittings are normally used for end-for-end gybing but can be used for vertical pole stowage and dip gybing as well.

Our traditional aluminium fittings for dip gybing are available for the Ø 72-Ø 111 sections.

Trip trigger

All aluminium fittings and composite fittings for Ø 72-Ø 111 poles are available with a trip trigger function. You open the end fitting with a control line and the sheet locks it automatically. This makes life easier for the fore-deck crew.

Four good ways

There are four basic ways to handle the spinnaker. The end-for-end method, with the topping lift and downhaul attached to the centre of the spinnaker pole, is most suitable for boats up to 25 feet in length. Another end-for-end method, with the topping lift at the centre of the pole and



Small composite end fitting with stainless chafe guard and Dyneema bridle for downhaul.



Medium composite end fitting with stainless chafe guard, trip trigger and Dyneema bridle for downhaul.

The aluminium extrusions are fitted with pole savers to shield the pole against damage from forestay and shrouds.

the downhaul attached to the outboard end, is best for masthead rigged boats (max. 33 ft) and fractionally rigged boats (max. 40 ft). The third method, dip pole, is suitable for larger boats. The fourth way, twin pole arrangements, is recommended for yachts ranging from 40 feet and upwards. Twin poles make it much easier and safer to gybe with the spinnaker on a big yacht.

Section data

	Section dia., mm	I_y cm ⁴	I_x cm ⁴	Wall thickness, mm	Weight kg/m
	48/48	7.65	7.65	2.0	0.75
	60/60	15.4	15.4	2.0	1.00
	72/72	29.9	29.9	2.2	1.38
	84/84	48.0	48.0	2.2	1.53
	96/96	72.3	72.3	2.2	1.76
	99/99	123	123	3.6	2.65
	111/111	197	197	4.1	3.38

Composite spinnaker pole fittings

A lightweight composite fitting for fast and easy spinnaker handling. Stainless, spring loaded plunger. These fittings can be used for end-for-end gybing as well as vertical pole stowage and dip gybing.

Spinnaker poles with composite fittings come with Dyneema-core bridles for topping lift and downhaul. Can be secured in place without removing the fittings from the tube, which also makes it easier to change or adjust the bridles.

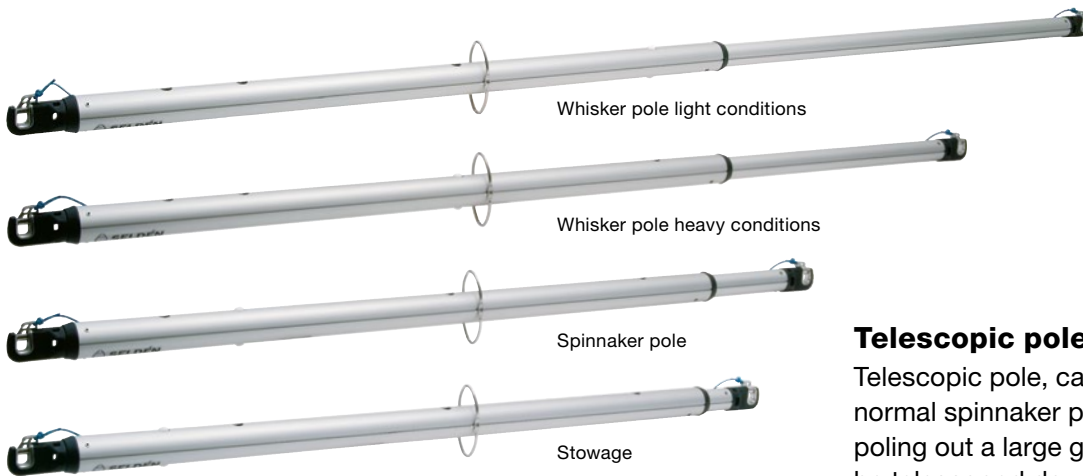

Telescopic pole. Maximises your downwind performance.
Minimises your stowage problem.

Telescopic poles

Telescopic pole, can be extended to 150% of normal spinnaker pole length, a must when poling out a large genoa or a gennaker. It can be telescoped down for easier stowage.

Art. No.	RM 30° kNm	Displ. tonnes	Section dia., mm		Weight kg	Min. length for stowage mm	Spinnaker pole postion mm	Whisker pole heavy conditions mm	Whisker pole light conditions mm
			Inner	Outer					
060-060-58	18	3.6	48	60	6	2530	3000	3600	4500
072-072-61	35	6.3	60	72	10	2950	3500	4200	5250
084-084-60	55	9.0	72	84	13	3280	3900	4875	5820

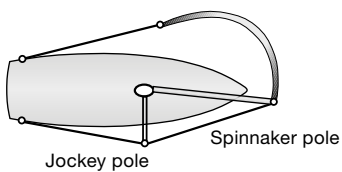

Jockey poles

The jockey pole reduces the loads and minimises the wear on guys and life lines.

*096-096-59 includes inboard end 534-778-04 and requires male fitting 508-149-01 at the mast.



Art. No.	RM 30° kNm	Sec- tion mm	Total length mm
060-060-55	26	60/60	1810
060-060-56	35	60/60	2010
084-084-58	90	84/84	2480
096-096-58	250	96/96	2760
096-096-59*	250	96/96	2840

Ready, set, go



Hook up the spinnaker. Set up the spinnaker pole, topping lift and downhaul. Adjust the pole to suitable sailing trim. Haul in the windward guy. Also, haul in the leeward sheet to prevent the sail from twisting.



Hoist the spinnaker. It is a good idea if someone assists at the mast. Let the halyard run through a closed rope stopper. That way, you will not lose it if it fills early.



Make sure that the spinnaker runs free from the bag or through the forepeak hatch.



Call out "Top!" when the spinnaker is fully hoisted.



Adjust the guy and sheet.



Tidy up and hand in the jib.



When taking down the spinnaker, release the halyard first, followed by the leeward sheet. Do not release the windward guy until the spinnaker is fully down. If you want to read more about spinnaker sailing please order our free brochure, Using a spinnaker, Art. No. 595-560-E.

Carbon spinnaker poles



Seldén quality

We have developed our own computer controlled manufacturing method in which prepreg (pre-impregnated) tows are wound onto a mandrel (cylinder) prior to oven curing. This method enables us to exercise full control over every stage of the manufacturing process and guarantee products of consistently high quality. One of the big advantages of this Seldén production method is that it enables us to achieve sufficient durability in the areas subject to the greatest loads and wear.

In all sizes

Seldén carbon spinnaker poles are suitable for dinghies and for yachts up to 30 tonnes. The larger poles are tapered to optimise weight/strength requirements, and facilitate handling.



Seldén spinnaker poles are designed to make light work of spinnaker handling. The big advantage of carbon fibre is its low weight. The weight savings enable the crew to handle the spinnaker faster, with less effort.



Carbon spinnaker poles (dimensions 47/47 and 59/59) with small composite end fittings and Dyneema bridle.



Carbon spinnaker poles (dimensions 77/77 and 88/88) with medium composite end fittings, trip trigger and Dyneema bridle.



Dip pole, trip trigger end fitting.



Female casting for clip-on spigot.



Harken end fitting for larger poles.

Weight comparison – aluminium and carbon spinnaker poles (equal strength).
Aluminium spinnaker pole Section 99/99, length 5150 mm, weight 16.9 kg.
Carbon spinnaker pole Section 102/102, length 5150 mm, weight 9 kg.

Seldén carbon spinnaker poles

Type	Section dia., mm	Weight kg/m	Inertia Al-equivalent cm ⁴
Untapered tube	47	0.33	5.4
	59	0.42	10.8
	61	0.59	18.5
	77	0.65	42.3
	88	1.00	63
	90	1.26	88
Tapered tube	102	1.15	134.6
	119	1.68	217
	137	1.94	335
	156	2.69	508
	158	3.15	642



Twaron protection can be supplied as an option. Twaron filaments protect the pole from damage caused by the forestay and shrouds.

Selecting the right pole

Just look in the appropriate table for your yacht's displacement or righting moment (RM) at 30° heel, then look right for the value exceeding your SPL or J value (shown in the sail plan).

Example: For an aluminium spinnaker pole. Yacht displacement 8.0 tonnes, SPL is 6100 mm. The correct section is 99/99.



Table terminology

RM: Righting moment at 30° of heel.

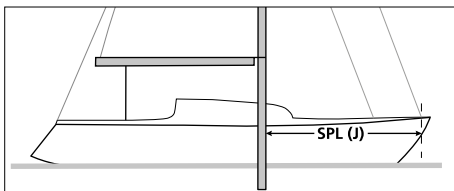

SPL (J): Maximum spinnaker pole length for your yacht.

A whisker pole should be approximately as long as the foot of the sail you intend to pole out.

Topping lift

When SPL is within 500 mm of a dimension shown in **bold blue**, a bridle topping lift is recommended if downhaul is at outboard end of pole. For 99/99 and larger diameter poles, use outboard end lift only.

Downhaul

Poles should have downhaul attached via a bridle or at outboard end. If a central attachment is desired, the pole diameter must be increased to the next size up.

Aluminium spinnaker pole selection max SPL (mm)

RM 30° kNm	Displ. tonnes	48/48	60/60	72/72*	84/84*	96/96	99/99	111/111
8	1.6	3000						
10	2.0	2700						
12	2.4	2500	3600					
14	2.8	2400	3500					
16	3.2	2350	3400					
18	3.6	2300	3300					
20	4.0	2250	3200	4650				
25	5.0		3000	4250				
30	5.7		2850	3905	5010			
35	6.3		2730	3720	4710			
40	7.0		2600	3520	4460	5480		
45	7.7			3360	4260	5230		
50	8.2			3220	4080	5010	6530	
55	9.0				3930	4820	6290	
60	10					4660	6070	
70	11					4380	5710	7230
80	12					4150	5410	6580
90	14						4950	6540
100	15						4770	6270
110	16						4600	6030
120	18							5830
130	19							5640
140	20							5330
150	22							5190
160	23							4950
180	26							4750
200	28							
220	31							
240	34							

* Max available SPL with composite end fittings, attached to a fixed mast ring. If the pole is to be "Dip Gybe", max available SPL is increased by 165 mm.



Aluminium whisker pole selection max pole length (mm)

RM 30° kNm	Displ. tonnes	48/48	60/60	72/72	84/84	96/96	99/99
12	2.4	3200					
14	2.8	3200					
16	3.2	3200					
18	3.6	3200					
20	4.0	3150	4700				
25	5.0	2800	4700	5240			
30	5.7	2550	4700	5240	5240		
35	6.3		4400	5240	5240		
40	7.0		4100	5210	5240		
45	7.7		3800	4970	5240		
50	8.2		3650	4770	5240	6280	
55	9.0			4590	5240	6280	6530
60	10			4430	5240	6280	6530
70	11				5240	6280	6530
80	12				5010	6140	6530
90	14					5860	6530
100	15						6530
110	16						6530



Downhaul

Poles should have the downhaul attached via a bridle or at the outboard end. If a central attachment is desired, the pole diameter must be increased to the next size up.



Topping lift/Downhaul

Central attachment points for lift and downhaul are not available. End-for-end poles have optional bridles made from the core of spectra rope. Poles for dip gybe always use the out-board end attachments.

Table terminology

RM: Righting moment at 30° of heel.

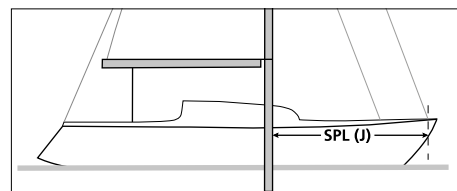

SPL (J): Maximum spinnaker pole length for your yacht.

A whisker pole should be approximately as long as the foot of the sail you intend to pole out.

Carbon spinnaker pole selection max SPL (mm)

RM 30° kNm	Displ. tonnes	47/47	59/59	61/61	77/77	88/88*	90/90*	102/102	119/119	137/137	156/156	158/158
8	1.6	2850										
10	2.0	2610	3710									
12	2.4	2430	3450	4490	4810*							
14	2.8	2280	3420	4220	4810*							
16	3.2	2160	3070	4000	4810*							
18	3.6	2070	2930	3820	4810*							
20	4.0		2810	3660	4810*	5450*						
25	5.0		2750	3350	4810*	5450*						
30	5.7		2390	3110	4710	5450*	5450*					
35	6.3			2930	4430	5440	5450					
40	7.0				4200	5160	5450	6500				
45	7.7				4000	4920	5450	6500				
50	8.2				3840	4720	5450	6500	8500			
55	9.0					4540	5330	6500	8360			
60	10					4390	5150	6360	8080			
70	11					4120	4840	5980	7590	9370		
80	12					3910	4590	5670	7200	8950		
90	14					3730	4380	5410	6870	8540	9370	
100	15						4200	5190	6590	8180	9370	
110	16							4990	6340	7880	9370	
120	18							4820	6120	7610	9360	
130	19							4670	5930	7370	9070	
140	20							4530	5760	7150	8800	9370
150	22								5600	6960	8560	9370
160	23								5460	6780	8340	9370
180	31								5210	6470	7960	8980
200	32								4990	6200	7630	8610
220	34								4810	5970	7350	8290
240	35									5770	7090	8000
260										5590	6870	7750

* Max available SPL with composite end fittings, attached to a fixed mast ring. If the pole is to be "Dip Gybe", max available SPL is increased by 65 mm.



Carbon whisker pole selection max pole length (mm)

RM 30° kNm	Displ. tonnes	47/47	59/59	61/61	77/77	88/88*	90/90*	102/102	119/119	137/137	156/156
8	1.6	3700									
10	2.0	3700									
12	2.4	3580	5100								
14	2.8	3380	4800	5230							
16	3.2	3200	4550	5230							
18	3.6	3060	4340	5230	4810*						
20	4.0	2930	4160	5230	4810*						
25	5.0	2680	3810	4950	4810*	5450*					
30	5.7		3540	4600	4810*	5450*	5450*				
35	6.3		3330	4330	4810*	5450*	5450*				
40	7.0		3150	4100	4810*	5450*	5450*				
45	7.7			3920	4810*	5450*	5450*	6500			
50	8.2			3750	4810*	5450*	5450*	6500			
55	9.0			3610	4810*	5450*	5450*	6500	8500		
60	10				4810*	5450*	5450*	6500	8500		
70	11				4810*	5450*	5450*	6500	8500	9370	
80	12				4710*	5450*	5450*	6500	8500	9370	
90	14					5450*	5450*	6500	8500	9370	9370
100	15					5280	5450*	6500	8500	9370	9370
110	16					5080	5450*	6500	8500	9370	9370
120	18						5450*	6500	8500	9370	9370
130	19						5450*	6500	8500	9370	9370
140	20						5430	6500	8500	9370	9370
150	22							6500	8290	9370	9370
160	23							6360	8080	9370	9370
180	31							6070	7710	9370	9370
200	32							5820	7390	9180	9370
220	34								7110	8840	9370
240	35								6870	8540	9370
260										8270	9370

* Max available SPL with composite end fittings, attached to a fixed mast ring.
If the pole is to be "Dip Gybe", max available SPL is increased by 65 mm.

Spinnaker pole kits

There is no need to wait for Seldén to build your customized spinnaker pole. You can easily build it yourself from one of our kits. Your local Seldén dealer will, of course, be happy to do the job for you.

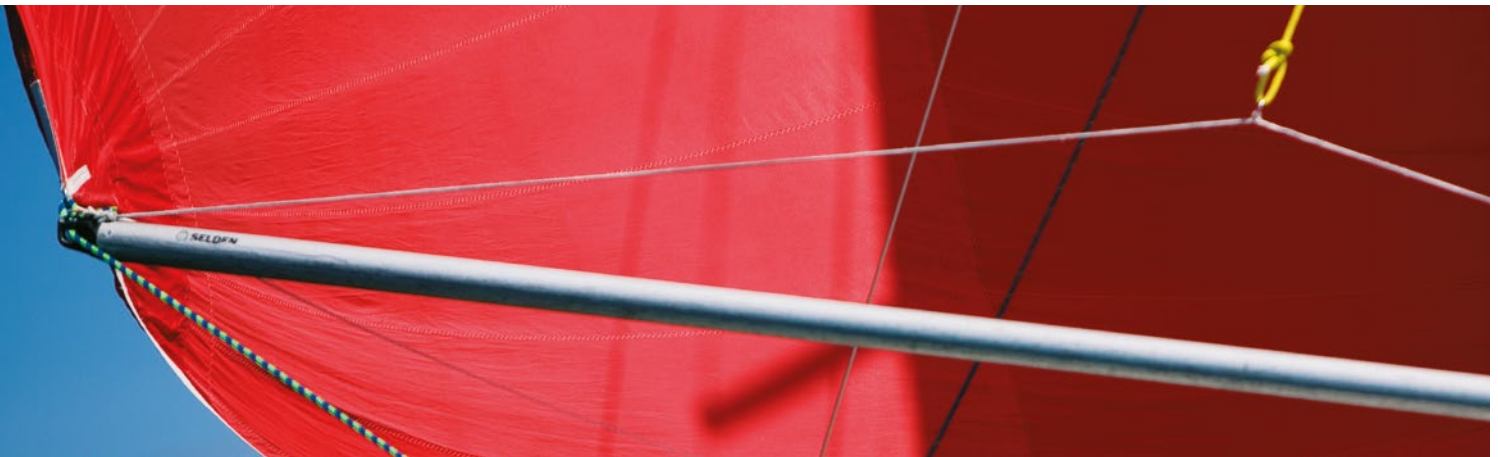

Aluminium spinnaker pole kits

Fittings designed for:
End-for-end gybing, dip pole gybing and vertical pole stowage.

Art. No.	Section, dia., mm	Max spinnaker pole length, mm	Type of end fitting
048-048-54	48	3180	2 of 534-865
060-060-54	60	3720	
060-060-68		5220	2 of 534-854*
072-072-57	72	4180	
072-072-68		5180	
084-084-57	84	4720	
084-084-68		5220	2 of 534-854*
096-096-68**	96	6260	

* Trip trigger retrofit kit, Art. No. 534-857-01.

** Only to be used as a whisker pole.

Aluminium spinnaker pole kits

Fittings designed for: Dip pole gybing and vertical pole stowage.

Art. No.	Section dia., mm	Max spinnaker pole length, mm	Type of end fitting
072-072-67	72	5245	534-854* Outboard end
084-084-67	84	5285	534-778 Inboard end
096-096-67	96	6500	534-777 Outboard end
099-099-67	99	6500	534-778 Inboard end

* Trip trigger retrofit kit, Art. No. 534-857-01.

Single tapered Carbon spinnaker poles - Made to order. Tapered outer end.





Fittings designed for dip gybing and vertical pole stowage.

Includes; Outboard end with trip-trigger function, trip-line, retraction cord for spinnaker lift and lift-eye.

Art. No	Section Dia., mm	Max spinnaker pole length, mm	Type of end fitting
SSC102-54	102	6340	Inboard end: 534-778
SSC119-54	119	8340	Outboard end: 534-777

Carbon spinnaker pole kits

Fittings designed for: End-for-end gybing, dip pole gybing and vertical pole stowage.

Art. No.	Section Dia., mm	Max SPL, mm	Type of end fitting	Carbon tube only	Section Dia., mm	Max length mm
047-047-01	47	2680	2 of 534-865			
047-047-02		3180				
047-047-03		3680		535-549-03	47	3500
059-059-01	59	3220				
059-059-02		3720				
059-059-03		4220		535-550-03	59	4000
061-061-01	61	3220				
061-061-02		3720				
061-061-03		4220		535-554-03	61	4000
061-061-04		5220		535-554-04	61	5000
077-077-01	77	3680	2 of 534-854*			
077-077-02		4480				
077-077-03		4780		535-567-03	77	4600
088-088-01	88	4230				
088-088-02		4930		535-552-02	88	4700
088-088-03		5430		535-552-03	88	5200
090-090-01	90	4230				
090-090-02		4930				
090-090-03		5430		535-564-03	90	5200

* Trip trigger retrofit kit, Art. No. 534-857-01. SPL = Spinnaker Pole Length.

Carbon spinnaker pole kits

Fittings designed for: End-for-end gybing, dip pole gybing and vertical pole stowage.

Art. No.	Section dia., mm	Max spinnaker pole length, mm	Type of end fitting
077-077-21	77	3755	Inboard end, 534-778
077-077-22		4555	
077-077-23		4855	
088-088-21	88	4295	Outboard end, 534-854*
088-088-22		4995	
088-088-23		5495	
090-090-21	90	4295	
090-090-22		4995	
090-090-23		5495	

* Trip trigger retrofit kit, Art. No. 534-857-01.

Tools for working with carbon fibre

Art. No.	Description	Used for section, dia., mm
592-079	Drill Ø 4,1	-
592-080	Drill Ø 4,8	47, 59, 61
592-081	Drill Ø 6,4	77, 88, 90
592-102	Hacksaw blade	All

Warning: Always use breathing protection when drilling or cutting carbon products.

Twaron protection

Protects the pole from damage from the forestay, rail impact, etc. Two protectors needed for end-for-end poles.

For section, mm	One protector, for dip pole gybing, Art. No.	Two protectors, for end-for-end gybing, Art. No.
59	-	535-586-02
61	-	535-593-02
77	535-599-01	535-599-02
88	535-588-01	535-588-02
90	535-594-01	535-594-02



Bridle kit

Includes Ø4 mm HMPE* rope and stainless steel ring.

Art. No.	For max spinnaker pole length, mm
613-051-04	3250
613-051-05	4500
613-051-06	5500

* High modulus polyethylene.

Exit box for trip line

For dip pole gybing, the trip line must exit through an exit box. For further information, see instruction 595-415-E on www.seldenmast.com.



Art. No.	Dimensions, mm
505-069-11	21x9



Spinnaker halyard attachments

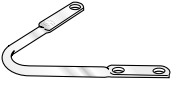
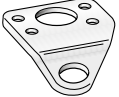

Masthead rig or fractional. Seldén offers a full range of single and double spinnaker halyard attachments.

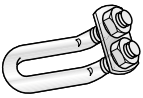
	Mast section	Single fitting Art. No.	Dimensions mm	Double fitting Art. No.	Dimensions mm	Remarks
Loop 	Fits small mast sections	508-034-01	Ø 6 Width: 65			
Bracket 	E189-E206 R190-R213 C156-C227 F176-F228	508-182-01	86 x 100	508-191-01	86 x 100	Max. RM: 60 kNm
Bracket 	C245-C304 F246-F305	508-247-01	135 x 145 x 6			Max. RM: 60 kNm
U-bolt 	E224, E237 R214, R232, R260 C156-C285 F176-F286	508-023-01	Ø 8 Width: 53			Max. RM: 100 kNm
	E274 R290 C304 F305		Ø 12 Width: 70			Max. RM: 180 kNm
	E321, E365 R290-R370 C285-C365 F324-F370		Ø 12 Width: 70			With fitted lower washer Max. RM: 250 kNm



Spinnaker pole attachments

Seldén has the right attachment for all your needs – dip pole or end-for-end arrangement, RCB cars and slide cars, including cars for vertical pole stowage.

Jockey poles, fixed eye

Inner diameter 30 mm

Mast section	Art. No.
E155, E170, E177, E189 E206, E224, E237, E274 D137, D146, D160	534-509-01
R190, R214, R213, R235 R232, R260, R290 All C-sections and F-sections	534-514-01

Spinnaker poles, fixed eye

Inner diameter 30 mm

Mast section	Art. No.
P90, E122, C156	534-531-01
P100, P111, E130, D121, D129, E138, E155, D160, R190, R213, C137, C153, C175-C227, F176-F228	534-528-01
E170, E177, E189, E206, D146, R235, R232, R260, R290, C245-C304, F246-F265	534-529-01
E224, E237, E274	534-507-01
F286-F305	534-529-02

Modify base to match front radius of section.

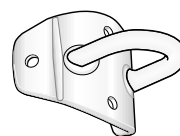

Art. No. 534-528.

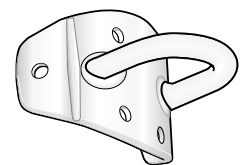









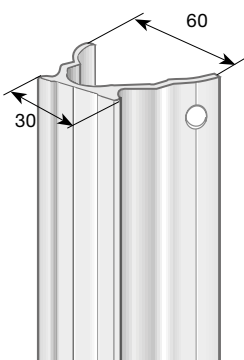
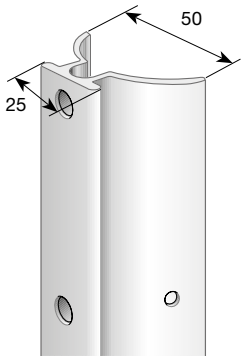

Art. No. 534-529.



Art. No. 511-585-04.

Spinnaker pole cars, RCB



Type of car		Art. No. 1:1 purchase	Art. No. 2:1 purchase	Track width mm	Spinnaker pole end fitting, Art. No.	Max. RM
	10° car	511-585-06	511-585-16	30	-	120 kNm
	10° car for vertical pole stowage	511-585-01	511-585-11	30	534-865 Small 534-854 Medium	120 kNm
	10° bayonet car	511-585-04	511-585-14	30	534-778	120 kNm
	Ring car with eyes for lift and downhaul	511-585-03	511-585-13	30	534-865 Small 534-854 Medium	120 kNm
	10° bayonet	511-585-29	511-585-39	30	534-798-04	120 kNm
	10° vertical pole stowage, double car with bayonet	511-585-05		30	534-778	240 kNm
	0° standard double car with bayonet	511-585-07		30	534-778	240 kNm
	10° vertical pole stowage, double car with bayonet	511-585-28		30	534-798-04	240 kNm
	0° standard double car with bayonet	511-585-30		30	534-798-04	240 kNm

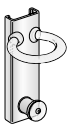
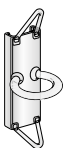
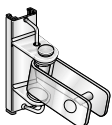
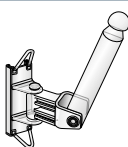

Spinnaker pole sliders

Type of slider	Art. No.	Ring inner dia., mm	Track width mm	Spinnaker pole end fitting, Art. No.	Max. RM	Sliding inserts Art. No.
 Ring slider with locking device.	511-505-01	30	25	534-865/534-854	45 kNm	530-705
	511-526-01		32			530-712
 Ring slider with eyes for lift and downhaul.	511-536-01	30	32	534-778	45 kNm	530-712
	511-536-02		RCB 30		120 kNm	530-717
			25		45 kNm	530-705
 10° slider fore vertical pole stowage.	511-553-01*	With bayonet	25	534-778	45 kNm	530-705
	511-554-01*		32		45 kNm	530-712
	511-554-03*		RCB 30		75 kNm	530-717
	511-553-04		25		45 kNm	530-705
	511-554-02		32		45 kNm	530-712
 Slider with eyes for lift and downhaul.	511-554-04	With bayonet 10°	RCB 30	534-778	75 kNm	530-717

* These sliders include toggle 534-800, designed for our composite end fittings (page 150).



Composite spinnaker pole fitting,
Art. No. 534-865.



Composite spinnaker pole fitting,
Art. No. 534-854.



Inboard end fitting, for bayonet
slider. Art. nr. 534-778.



Outboard aluminium end fitting.
Art. No. 534-777.

Spinnaker pole fittings

End fitting	Material	Art. No.	Trip trigger function	Pole section	Adaptor Art. No.	
Small*	Composite	534-865-01	No	48/48	-	
		534-865-03		60/60	534-779	
Medium*		534-854-01	No	72/72	-	
		534-854-11		Yes	-	
		534-854-03	No	84/84	534-781	
		534-854-13	Yes	-		
		534-854-04	No	96/96	534-782	
		534-854-14	Yes	-		
Outboard		Aluminium	534-777-01	Yes	72/72	-
			534-777-03		84/84	534-781
	534-777-12		96/96		534-782	
	534-777-12		99/99		534-782	
	534-777-06		111/111		534-801	
Inboard	534-778-01		-	72/72	-	
	534-778-02			84/84	534-781	
	534-778-04			96/96	534-782	
	534-778-04			99/99	534-782	
	534-778-04			111/111	534-801	
	534-778-06			111/111	534-801	

* Designed for 30 mm mast eyes.

Jockey pole fitting, outboard end



Jockey pole fitting.

End fitting	Art. No.	Pole section dia., mm	Adaptor Art. No.
Small	534-964-01	48	-
	534-964-02	60	534-779
Medium	534-965-01	72	-
	534-965-02	84	534-781
	534-965-03	96	534-782



Spinnaker pole heel lift system



The heel lift system provides effortless spinnaker handling and allows the crew to set the spinnaker in the perfect position.

Tracks not included in the heel lifting system. See page 153.

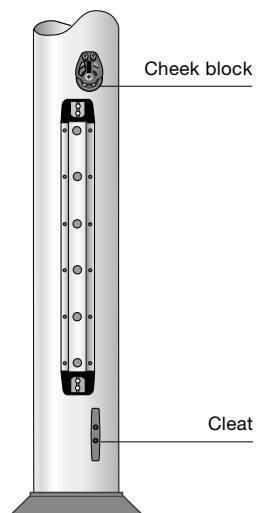

C175-F246, E122-E206:
Art. No. 405-001-81
 (cleat Art. No. 511-016*).

C227-F246, E177-E206:
Art. No. 405-001-82 (cleat Art. No. 511-031*).

C264-F305, E237-E274:
Art. No. 406-001-83 (cleat Art. No. 511-015*).

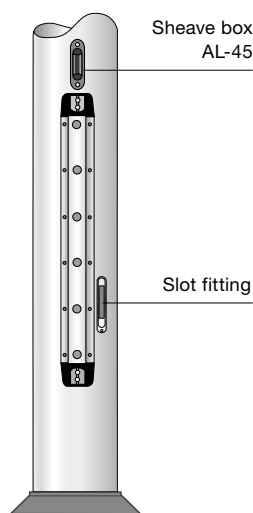

Art. No. 538-508-06.
 Operation from cockpit.

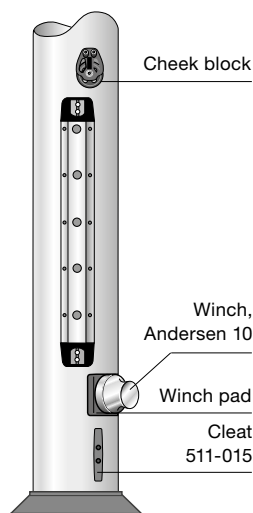

Art. No. 406-001-87.

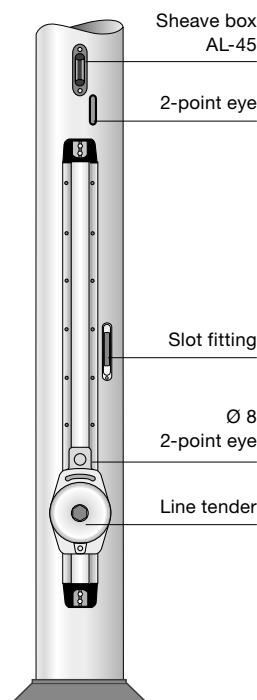

Art. No. 538-508-11.

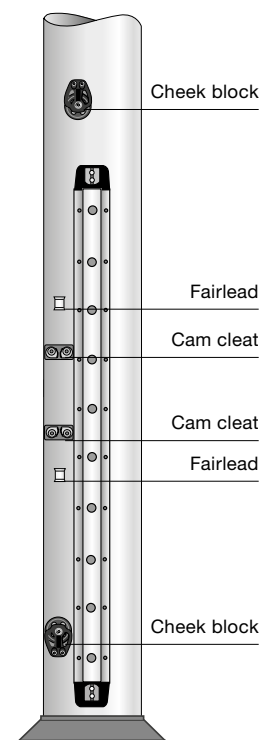

C175-C245:
Art. No. 405-001-85.
 C264:
Art. No. 406-001-85.

*For more information about cleats, see page 5.

Stowage brackets

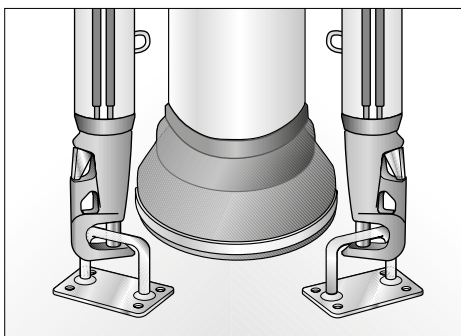

Art. No. 508-145.
Art. No. 508-398.

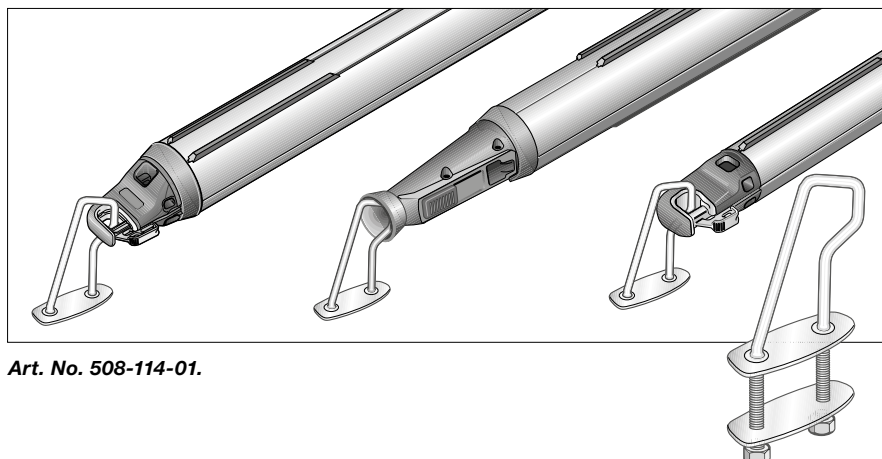

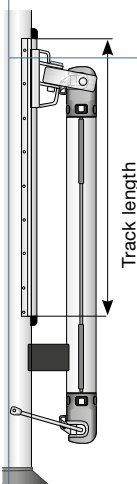

Art. No. 508-114-01.

Vertical pole stowage

Mast section		Track width 25 mm, radius 34*, ** Length 1700 mm, Art. No. 515-504-01 Length 3400 mm, Art. No. 515-512-01			
E122, E130 D137, E138 E155, D160 R190, R213 R235 C156-C264 F176-F265		Vertical pole stowage		End-for-end spinnaker pole slider	
		End-for-end slider for pole sections 48/48-96/96 Carbon 47/47 and 88/88 Art. No. 511-553-01	Bayonet slider for pole sections 72/72 and 84/84 Carbon 77/77-118/118 Art. No. 511-553-04	Ring slider with locking device Art. No. 511-505-01	
		Spi-pole lift system, see page 152			
		Loop + support Art. No. 508-090-02			

* For yachts with an RM over 25 kNm fit track with double pop rivets. Art. No. 167-018 (Ø 4.8x12.7 mm). 14 extra pop rivets/track.

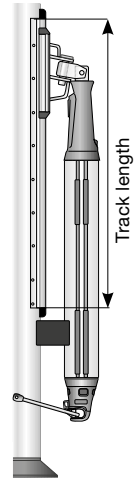
** End stops and pop rivets included.

Mast section		Track width 30 mm, radius 38 ** Track incl. Ø 6.4x12.7 mm pop rivets: Length 2400 mm, Art. No. 515-567-02 Length 3400 mm, Art. No. 515-550-02 Length 4800 mm, Art. No. 515-551-02 Track incl. Ø 6.4x17.8 mm pop rivets: Length 2400 mm, Art. No. 515-567-06 Length 3400 mm, Art. No. 515-550-06 Length 4800 mm, Art. No. 515-551-06					
Ø 6.4x12.7 mm pop rivets: E170 D146, D160 R213, R235 C193-C264 F194-F265 Ø 6.4x17.8 mm pop rivets: R232, R260 C285 F286		Vertical pole stowage			End-for-end spinnaker pole slider		
		End-for-end slider for pole sections 72/72-96/96 Carbon 77/77-88/88 Art. No. 511-554-03	End-for-end RCB spinnaker pole car for sections 72/72-96/96 Carbon 77/77-88/88 Art. No. 511-585-01	Bayonet RCB spinnaker pole car for sections 72/72 and 111/111 Carbon 77/77-118/118 Art. No. 511-585-04	Ring slider with eyes for lift and downhaul Art. No. 511-536-02	RCB ring slider with eyes for lift and downhaul Art. No. 511-585-03	
		Spi-pole lift system, see page 152					
		Loop + support Art. No. 508-090-02					
Ø 6.4x12.7 mm pop rivets: E177, E189 E206, E224 E237 C321* C304* Ø 6.4x17.8 mm pop rivets: E274*, E365* R290*, F324* F305*, C365, F370*		Track width 30 mm, radius 54 ** Track incl. Ø 6.4x12.7 mm pop rivets: Length 2400 mm, Art. No. 515-568-02 Length 3400 mm, Art. No. 515-552-02 Length 4800 mm, Art. No. 515-553-02 Track incl. Ø 6.4x17.8 mm pop rivets: Length 2400 mm, Art. No. 515-568-06 Length 3400 mm, Art. No. 515-552-06 Length 4800 mm, Art. No. 515-553-06					
		Vertical pole stowage			End-for-end spinnaker pole slider		
		End-for-end slider for pole sections 72/72-96/96 Carbon 77/77-88/88 Art. No. 511-554-03	End-for-end RCB spinnaker pole car for sections 72/72-96/96, 72/72-111/111 Carbon 77/77-88/88 Art. No. 511-585-01	Bayonet RCB spinnaker pole car for sections Carbon 77/77-118/118 Art. No. 511-585-04	Ring slider with eyes for lift and downhaul Art. No. 511-536-02	RCB ring slider with eyes for lift and downhaul Art. No. 511-585-03	
		Spi-pole lift system, see page 152. Loop + support Art. No. 508-090-02 Art. No. 508-212-02 for C304/F305/C321/F324					

Calculate track length: Min. = Spinnaker Pole Length (SPL) minus 1500 mm. Max. = SPL minus 600 mm. If the spinnaker pole track passes a P-spreader bracket, "bedding" must be used. Art. No. 535-125 (L = 4000 mm).

Calculate length of pole heel lift rope: 2 x SPL + 2 metres.

* Use stowage bracket Art. No. 508-145 or 508-398.

** End stops and pop rivets included.



Gennaker bowsprit

Extendable gennaker bowsprit sold as a kit for deck mounting. Just fit the two stainless steel pad eyes to the deck in line with the bow bracket. The bracket is a stainless ring with a low friction polyamide inner lining through which the bowsprit slides into its “active” position. After the gennaker is doused, the bowsprit can slide back and be secured to the aft eye. If required,

it can be quickly removed and stowed securely below.

The gennaker tackline runs through the bowsprit, entering and leaving via well rounded holes, and then aft to the cockpit. An alternative is to fit an external tack block at the outboard end.

- Gives the gennaker more clear air
- Facilitates rapid gybing
- Always ready for quick extension
- Makes for fast and efficient gennaker handling
- Improves performance when gennaker sailing
- Can be fitted to most yachts
- Available in carbon or aluminium



Spring-loaded locking device for safe and easy handling.

Bowsprit kits

The kit includes: Aluminium or carbon bowsprit section, inboard end fitting with plunger, outboard end fitting, 2 stainless steel pad eyes, instructions.

	Description	Dimension (mm)		Art. No.
Aluminium	G072	Ø72/72	L=< 2080 mm	072-072-70
	G075	Ø75/75	L=< 2230 mm	075-075-70
	G087	Ø87/87	L=< 2270 mm	087-087-70
	G099	Ø99/99	L=< 3160 mm	099-099-70
Carbon	GC076	Ø76/76	L=< 3000 mm	076-076-70
	GC088	Ø88/88	L=< 3000 mm	088-088-70
	GC089	Ø89/89	L=< 3000 mm	089-089-70
	GC100	Ø100/100	L=< 3000 mm	100-100-70
	GC101	Ø101/101	L=< 3000 mm	101-101-70



Side mounted installation on stem head anchor fitting



Bow fittings on some boats can be integrated with the bow anchor fitting.

Bow bracket

		Bowsprit, diameter (mm)	Art. No.
	Stainless steel bow bracket with PA inner lining. To be bolted to deck or rail.	Ø 72/72	508-783-01
		Ø 75/75 Ø 76/76	508-783-02
		Ø 87/87 Ø 88/88 Ø 89/89	508-783-04
		Ø 99/99 Ø 100/100 Ø 101/101	508-794-05
	Stainless steel bow ring with PA inner lining. Can be welded to bow anchor fitting or sturdy pulpit.	Ø 72/72	508-758-01
		Ø 75/75 Ø 76/76	508-758-02
		Ø 87/87 Ø 88/88 Ø 89/89	508-758-04
		Ø 99/99 Ø 100/100 Ø 101/101	508-757-05
	Stainless steel bow fitting with PA inner lining bushing. Can be integrated with some bow anchor fittings (e.g. Jeanneau). Width of base: 175 mm. Fitted with Ø 12 mm bolt.	Ø 72/72	508-782-01
		Ø 75/75 Ø 76/76	508-782-02
		Ø 87/87 Ø 88/88 Ø 89/89	508-782-04
	90° bracket and bow ring for assembly on bow anchor fitting.	Ø 72/72	508-834-11
		Ø 75/75 Ø 76/76	508-834-12
		Ø 87/87 Ø 88/88 Ø 89/89	508-834-14
		Ø 99/99 Ø 100/100 Ø 101/101	508-834-15

Dimensioning for gennaker, Aluminium

RM 30° (kNm)	Approx. displ. (tonnes)	G072		G075		G087		G099	
		Max USL	Min DBS	Max USL	Min DBS	Max USL	Min DBS	Max USL	Min DBS
8	1.7	1500	580						
10	2.1	1500	580						
12	2.4	1500	580						
14	2.8	980	580						
16	3.1	890	580	1580	600				
18	3.4	820	580	1450	600				
20	3.7	760	580	1340	600				
25	4.5	650	580	1140	600	1460	700	1930	800
30	5.2	570	580	1000	600	1280	700	1690	800
35	5.9	510	580	900	600	1150	730	1510	880
40	6.7	460	580	820	610	1040	780	1380	930
45	7.3			750	650	960	830	1270	990
50	8.0			700	700	890	890	1170	1050
55	8.7			650	750	830	960	1100	1120
60	9.3			610	810	780	1030	1030	1200
65	10.0			580	880	740	1130	970	1280
70	10.6					700	1220	920	1380
75	11.3					670	1350	880	1500
80	11.9					640	1490	840	1640
85	12.5					610	1650	800	1780
90	13.1							770	1960
95	13.8							740	1)
100	14.4							720	1)
105	15.6							690	1)
110	16.0							670	1)
115	16.1							650	1)
120	16.7							630	1)
125	17.3							610	1)
130	17.9							600	1)
135	18.5							580	1)
140	19.0							570	1)
145	19.6							550	1)
150	20.2							540	1)
155	21							530	1)

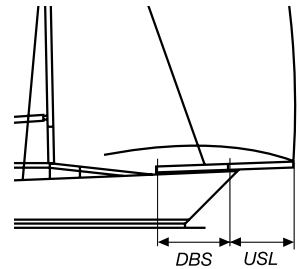

DBS = Distance between support.
USL = Unsupported length.



Bold numbers mean min DBS is limited by bowing capacity. If a custom bowing is used, the min DBS is 8 x pole diameter.

1) No standard bow bracket is available. If a custom bowing is used, the min DBS is 8 x pole diameter.

Dimensioning for Code 0, Aluminium

RM 30° (kNm)	Approx. displ. (tonnes)	G072		G075		G087		G099	
		Max USL	Min DBS	Max USL	Min DBS	Max USL	Min DBS	Max USL	Min DBS
8	1.7	580	580	1020	600	1300	700	1720	820
10	2.1	490	580	870	600	1110	740	1460	890
12	2.4	430	580	760	640	980	830	1280	970
14	2.8	390	580	680	710	870	910	1150	1070
16	3.1	350	580	620	800	790	1010	1050	1190
18	3.4	330	580	570	900	730	1150	960	1310
20	3.7	300	580	530	1030	680	1310	890	1470
25	4.5			450	1530	580	1)	760	2050
30	5.2			400	1)	510	1)	760	1)
35	5.9							600	1)
40	6.7							540	1)

Bold numbers mean min DBS is limited by bowing capacity. If a custom bowing is used, the min DBS is 8 x pole diameter.

1) No standard bow bracket is available. If a custom bowing is used, the min DBS is 8 x pole diameter.

Dimensioning for gennaker, Carbon

RM 30° (kNm)	Approx. displ. (tonnes)	GC076		GC088		GC089		GC100		GC101	
		Max USL	Min DBS	Max USL	Min DBS	Max USL	Min DBS	Max USL	Min DBS	Max USL	Min DBS
8	1.7	1500	610								
10	2.1	1500	610								
12	2.4	1500	610	1500	700						
14	2.8	1490	610	1500	700						
16	3.1	1360	610	1500	700						
18	3.4	1240	610	1500	700	1500	710				
20	3.7	1150	610	1500	700	1500	710				
25	4.5	980	610	1300	700	1470	710	1500	800		
30	5.2	860	610	1140	700	1290	710	1500	800		
35	5.9	770	610	1020	700	1150	730	1500	870		
40	6.7	700	610	930	700	1050	780	1430	970	1500	1010
45	7.3	650	610	860	740	970	840	1320	1030	1500	1170
50	8.0	600	610	800	800	900	900	1220	1090	1470	1310
55	8.7	560	650	740	850	840	970	1140	1170	1380	1410
60	9.3	530	700	700	930	790	1040	1070	1240	1290	1500
65	10.0	500	760	660	1000	740	1130	1010	1340	1220	1610
70	10.6			630	1100	700	1220	960	1440	1160	1740
75	11.3			600	1210	670	1350	910	1550	1100	1880
80	11.9					640	1490	870	1690	1050	2040
85	12.5					610	1650	840	1860	1010	2240
90	13.1							800	2040	970	2470
95	13.8							770	1)	930	1)
100	14.4							740	1)	900	1)
105	15.6							720	1)	870	1)
110	16.0							700	1)	840	1)
115	16.1							670	1)	810	1)
120	16.7							650	1)	790	1)
125	17.3							640	1)	770	1)
130	17.9							620	1)	750	1)
135	18.5							600	1)	730	1)
140	19.0							590	1)	710	1)
145	19.6							570	1)	690	1)
150	20.2							560	1)	670	1)
155	21							550	1)	660	1)
160	22									640	1)
165	24									630	1)
170	25									620	1)
175	26									600	1)

Bold numbers mean min DBS is limited by bowring capacity. If a custom bowring is used, the min DBS is 8 x pole diameter.

1) No standard bow bracket is available. If a custom bowring is used, the min DBS is 8 x pole diameter.

Dimensioning for Code 0, Carbon

RM 30° (kNm)	Approx. displ. (tonnes)	GC076		GC088		GC089		GC100		GC101	
		Max USL	Min DBS	Max USL	Min DBS	Max USL	Min DBS	Max USL	Min DBS	Max USL	Min DBS
8	1.7	880	610	1160	705	1310	710	1500	800		
10	2.1	750	610	990	705	1120	750	1500	920		
12	2.4	660	610	870	730	980	830	1330	1010	1500	1140
14	2.8	590	620	780	810	880	920	1190	1110	1440	1340
16	3.1	530	680	710	910	800	1030	1090	1230	1310	1480
18	3.4	490	770	650	1020	730	1150	1000	1360	1210	1650
20	3.7	460	890	600	1160	680	1310	930	1530	1120	1840
25	4.5			520	1770	580	1970	790	2130	950	2570
30	5.2							690	1)	840	1)
35	5.9							620	1)	750	1)
40	6.7							570	1)	680	1)
45	7.3							520	1)	630	1)
50	8.0									580	1)
55	8.7									540	1)
60	9.3									510	1)

Bold numbers mean min DBS is limited by bowring capacity. If a custom bowring is used, the min DBS is 8 x pole diameter.

1) No standard bow bracket is available. If a custom bowring is used, the min DBS is 8 x pole diameter.



LIGHTS

Masthead lights	160
Floodlights and steaming lights	161
Retro-fitting cables	162
Cable conduits	162
Cables and dimensions	162

*Spreader down-light will make your work on deck simpler and safer at night
and the up-lights will allow you to check the sail trim.
And yes....it looks really cool.*

Compulsory lights

International Regulations for Preventing Collisions at Sea, 1972, stipulate compulsory lights on all yachts. Seldén offers all the necessary lighting equipment to comply with the rules.



Tricolour/white
with or without anchor light.



Anchor light
Art. No. 526-163-01.

Masthead lights

Item	Size of boat	Fitting	Art. No.	Type of masthead	Required cable Art. No.
Anchor light 12V	For boats <7 m (Scandinavia) <12 m (International)	Base 508-549-01 incl.	526-163-01	15°	531-003
		Base 508-562 incl.	526-163-02	0°	
Anchor and steamlight 12V	For boats LOA <12 m	Stainless housing, base 508-562 incl.	526-026-01	0°	531-007
Aquasignal 41		Stainless housing, base 508-560 incl.	526-026-02	15°	
Windex light 12V	All	No fasteners required. Fit below Windex base.	526-153-01	See fig. 1	531-003
Tricolour lamp, Quick fit. 12V/24V	For boats LOA <20 m	Base 508-560 incl.	526-020-02/05	15°	531-006
		Base 508-562 incl.	526-020-03/06	0°	
Tricolour lamp/White, Quick fit. 12V/24V	For boats LOA <20 m	Base 508-560 incl.	526-021-02/05	15°	531-007
		Base 508-562 incl.	526-021-03/06	0°	

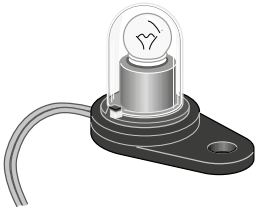

Windex light

Masthead lights, LED Aquasignal 34 12/24V

Item	Size of boat	Fitting	Art. No.	Type of masthead	Required cable Art. No.
Anchor light	For boats LOA <50 m Visibility 2nm	Base 508-560 incl.	526-036-02	15°	531-038
		Base 508-562 incl.	526-036-03	0°	
Tricolour light	For boats LOA <20 m Visibility 2nm	Base 508-560 incl.	526-075-02	15°	531-038
		Base 508-562 incl.	526-075-03	0°	
Anchor light and Tricolour light	For boats LOA <20 m Visibility 2nm	Base 508-560 incl.	526-038-02	15°	531-037
		Base 508-562 incl.	526-038-03	0°	
Steaming light with anchor light	For boats LOA <20 m Visibility 2nm	Base 508-560 incl.	526-070-02	15°	531-037
		Base 508-562 incl.	526-070-03	0°	



Aquasignal 34



Spreader light, LED for T-spreaders (see page 30)

Black anodized with circular light beam. LED 3,6W, 12/24V. Ref. Installation manual, 595-326-E

	Item	Spreader	Art. No.	Kit includes	Additional parts
	Flood light	T90-T131	526-182-01	1 light with housing and 1 m cable , screws, fairlead 508-609, pop-rivets, Male 3-pole socket 532-031	Female socket to fit on the mast: 532-030-03 Cable for installation in mast: 531-038 (2x0,5 mm2) Max length 12V: 19 m 24V: 74 m
	Up-light		526-182-02		
	Flood light and Up-light		526-182-03	2 lights with housing and 1 m cable , screws, fairlead 508-609, pop-rivets, Male 3-pole socket 532-031, cable terminals, heat shrink.	

Flood light and steaming light,LED

Recommended position: 27% of FH

	Item	Size of boat	Fitting	Art. No.	Required Cable, Art. No.
	Steaming light Hella Naviled Pro	LOA < 20 m Visibility 3nm	Base 535-614 (nylon) and self-tapping screws included.	526-081-01	15 m cable included
	Steaming light Hella Naviled Pro	LOA < 50 m Visibility 5nm	Base 523-047 (alu) and 3-pole male- and female connectors included	526-073-01	15 m cable included
	Steaming light with flood light (Hella/Cabin)	LOA < 20 m Visibility 3nm	Base 535-614 and self tapping screws included	526-081-02	15 m cable included

Flood light and steaming light

Item	Size of boat	Fitting	Art. No.	Remarks	Required cable Art. No.
Flood light, 12V/35W	All masts, front mounted	Black housing	526-156-01*	Pop rivets incl.	513-006
Flood light, 24V/50W			526-156-02*		
Flood light, 12V/35W		White housing	526-156-03*		
Flood light, 24V/50W			526-156-04*		
Steaming lights, 12V/10W Aquasignal 25	For boats LOA <7 m (Scandinavia) <12 m (international)	Base 508-566 incl.	526-015-01		531-003
Steaming lights, 12V/25W Aquasignal 41. Black composite	For boats LOA <12 m (Scandinavia) <20 m (international)	Base 508-614 incl.	526-009-03	Screws incl.	531-006
Steaming lights, 24V/25W Aquasignal 41. Black composite			526-009-04		
Steaming lights, 12V/25W Aquasignal 50. Stainless steel	For boats LOA <20 m	Protection loop 508-519 incl.	526-002-01	Fasteners incl.	
Steaming lights, 24V/25W Aquasignal 50. Stainless steel			526-002-02		
Protection loop, alum. (2 pcs) Aquasignal 50	For use with Aquasignal steaming lights		508-519-02		
Protection loop, stainless steel	E274, C304, F305 and bigger		508-172-01		

* Light insert: 12V (Art. No. 532-154), 28V (Art. No. 532-155).
O-ring for flood lights Art. No. 530-365.



Steaming light 526-009-03 and flood light 526-156-01

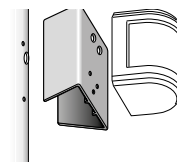

Nylon base for flood light. Suits most lights and mast sections. Art. No. 535-614.

Retro-fitting cables

For all D-sections, E-sections, P-sections and R-sections, please see our instruction "Running cables" 595-557-E. Also available from www.seldenmast.com.

Cable conduits

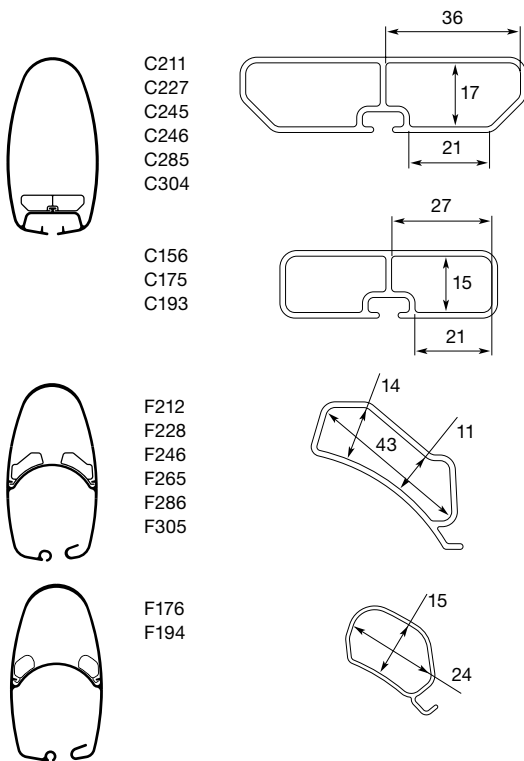

Cables and dimensions

Light	Effect	Cable length, m	Required cable area, mm ²
Anchor light	10W	0-33	1.5
		33-55	2.5
Steaming lights and navigation lights	10W	0-13	1.5
		13-22	2.5
	25W	0-5	1.5
		5-9	2.5
Floodlight	45W	9-14	4
		7-12	2.5
		12-20	4

All Seldén masts have a cable identification to facilitate connection when stepping the mast.

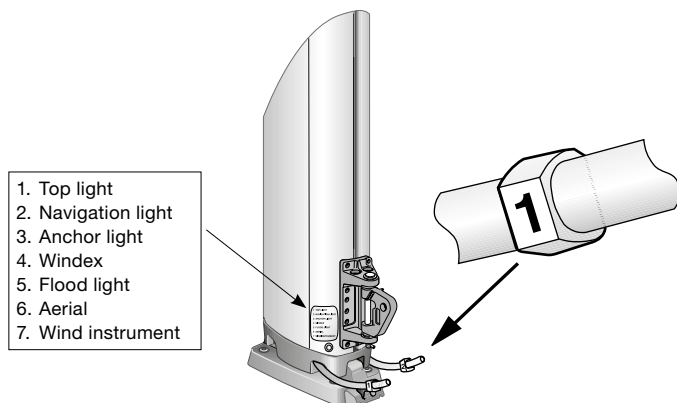

Cable for:	Cable area, mm ²	Art. No.	Remarks
Wind instrument	10 x 0.25	531-012	Ø 7.3 mm
Windex light, anchor light and steaming lights	2 x 1.5	531-003	Ø 6.9 mm
Tricolour/white/strobe	4 x 2.5	531-018	Ø 8.6 mm
Tricolour lamp, flood-light and steaming lights	2 x 2.5	531-006	Ø 7.6 mm
Tricolour lamp/white, anchor and steaming lights	3 x 2.5	531-007	Ø 8.1 mm
Aerial	RG 213U	531-010	50 ohm (min. for VHF-radio according to German standard) Ø 10.2 mm (Cable terminal Art. No. 532-021)
	RG 58U	531-024	50 ohm, Ø 5.4 mm (Cable terminal Art. No. 532-023)



Cable support

Protects the cable from wear in the exit area. Lead the cable out through a \varnothing 14 mm hole, jam the support onto the cable and plug the hole. Max cable size: $2 \times 2.5 \text{ mm}^2$ (\varnothing 7.6 mm). Art. No. 532-105.





All our rig fittings are manufactured using the very latest in production technology, to achieve maximum durability and corrosion resistance. All product development work is carried out at Seldén's own development department in Sweden.

We retain complete control over every aspect of the whole design and manufacturing process. By doing this, we can guarantee quality, and ensure that you get the most out of your rig.

RIG FITTINGS



Chrome bronze rigging screws	166
Backstay tensioners	172
Rigging screw covers	173
Hints	173
Fittings	174
Toggles	178
Split pin, split rings and clevis pin	179
Sheaves, bridles plates and insulators	181

Chrome bronze rigging screws



Bronze, like stainless steel, is very strong and highly resistant to corrosion. By making the body of the rigging screw in chrome plated aluminium bronze and the terminals in high grade marine stainless steel, we have reduced the risk of the thread seizing up under heavy loads. A design feature which gives you a product that performs better and lasts even longer. All Seldén rig screws are locked with split pins through the threaded terminals. A safe and proven method.

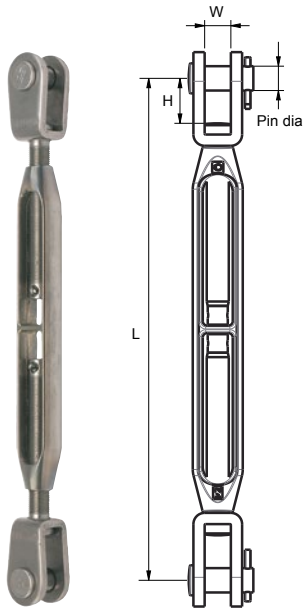

Fork + Fork

Art. no.	Thread size UNF	Length (L)		Clevis pin dia. mm	Internal fork height mm (H)	Internal fork width mm (W)	Breaking load kN
		Min. mm	Max. mm				
174-321-01	1/4"	135	205	6.5	12	7	15.5
174-322-01	5/16"	166	246	8	15	8	24.5
174-323-01	3/8"	197	298	9.5	18	10	34.5
174-324-01	7/16"	233	342	11	18	12	47.5
174-325-01	1/2"	268	413	13	24	14	62
174-326-01	5/8"	318	488	15.8	30	16	95
174-327-01	3/4"	370	572	15.8	32	20	125
174-327-02	3/4"	370	572	19	32	20	125
174-328-01	7/8"	443	676	19	45	22	180
174-328-02	7/8"	443	676	22	45	22	180
174-329-50*	1"	670	970	22	60	28	280
174-329-51*	1"	670	970	25	60	28	280
174-331-50*	1 1/4"	770	1120	29	70	31	320

*toggle fork + toggle fork

Fork + Stud terminal

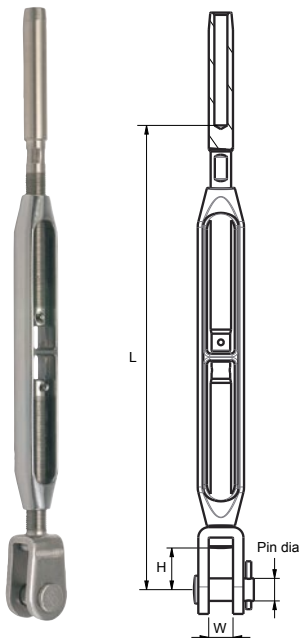

Art. no.	Thread size UNF	Wire dia. mm	Length (L)		Clevis pin dia. mm	Internal fork height mm (H)	Internal fork width mm (W)	Breaking load kN
			Min. mm	Max. mm				
174-321-05	1/4"	3	139	204	6.5	12	7	15.5
174-321-06	1/4"	4	139	204	6.5	12	7	15.5
174-322-05	5/16"	4	164	237	8	15	8	24.5
174-322-06	5/16"	5	176	249	8	15	8	24.5
174-323-05	3/8"	5	201	290	9.5	18	10	34.5
174-323-06	3/8"	6	200	289	9.5	18	10	34.5
174-324-05	7/16"	6	231	338	11	18	12	47.5
174-324-06	7/16"	7	231	338	11	18	12	47.5
174-325-05	1/2"	7	261	390	13	24	14	62
174-325-06	1/2"	8	258	387	13	24	14	62
174-326-05	5/8"	8	298	446	15.8	30	16	95
174-326-06	5/8"	10	303	451	15.8	30	16	95
174-327-05	3/4"	10	354	532	15.8	32	20	125
174-327-06	3/4"	12	356	534	15.8	32	20	125
174-327-07	3/4"	10	354	532	19	32	20	125
174-327-08	3/4"	12	356	534	19	32	20	125
174-328-05	7/8"	12	428	635	19	45	22	180
174-328-06	7/8"	14	436	648	19	45	22	180
174-328-07	7/8"	12	428	635	22	45	22	180
174-328-08	7/8"	14	436	648	22	45	22	180

Important note on 5/8" rigging screws

Back in 1998 we changed the clevis pin diameter from Ø 13 mm to Ø 15.8 mm. When upgrading to new rigging screws on a boat built prior to this change, the clevis pin will most likely be bigger than the chain plate hole. The Ø 15.8 mm clevis pin has to be replaced by one Ø 13 pin and two bushings.



Conversion kit,
Art. No. 306-558-03.

Toggle Fork + Fork

Art. no.	Thread size UNF	Length (L)		Clevis pin dia. mm	Toggel fork internal fork height, mm (H ²)	Internal fork height, mm (H ¹)	Internal fork width mm (W)	Breaking load kN
		Min. mm	Max. mm					
174-321-13	1/4"	150	220	6.5	15	12.5	7	15.5
174-322-13	5/16"	184	264	8	19	15	8	24.5
174-323-13	3/8"	220	321	10	22	18	10	34.5
174-324-13	7/16"	252	373	11	23,5	18	12	47.5
174-325-13	1/2"	294	439	13	30	24	14	62
174-326-13	5/8"	352	522	15.8	39.5	31	16	95
174-327-13	3/4"	411	612	15.8	40.50	32	20	125
174-327-14	3/4"	411	612	19	40.50	32	20	125
174-328-13	7/8"	495	676	19	55	45	23	180
174-328-14	7/8"	495	676	22	55	45	23	180

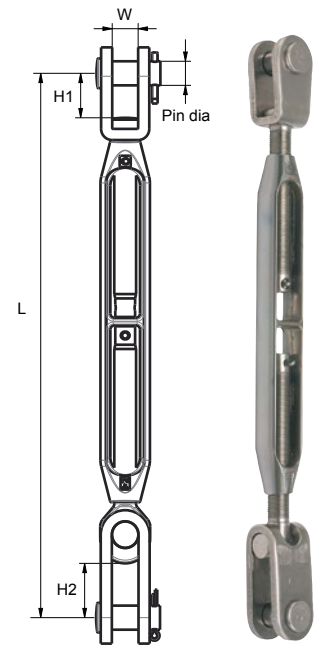

Toggle fork + Stud terminal

Art. no.	Thread size UNF	Wire dia. mm	Length (L)		Clevis pin dia. mm	Toggel fork internal fork height, mm (H)	Internal fork width mm (W)	Breaking load kN
			Min. mm	Max. mm				
174-321-39	1/4"	3	155	225	6.5	15	7	15.5
174-321-40	1/4"	4	155	225	6.5	15	7	15.5
174-322-39	5/16"	4	178	262	8	19	8	24.5
174-322-40	5/16"	5	178	262	8	19	8	24.5
174-323-39	3/8"	5	223	324	9.5	22	10	34.5
174-323-40	3/8"	6	223	324	9.5	22	10	34.5
174-324-39	7/16"	6	250	371	11	23.50	12	47.5
174-324-40	7/16"	7	250	371	11	23.50	12	47.5
174-325-39	1/2"	7	292	437	13	30	14	62
174-325-40	1/2"	8	292	437	13	30	14	62
174-326-39	5/8"	8	337	507	15.8	39.5	18	95
174-326-40	5/8"	10	337	507	15.8	39.5	18	95
174-327-39	3/4"	10	402	603	15.8	40.5	20	125
174-327-40	3/4"	12	402	603	15.8	40.5	20	125
174-327-41	3/4"	10	402	603	19	40.5	20	125
174-327-42	3/4"	12	402	603	19	40.5	20	125
174-328-39	7/8"	12	482	705	19	55	25	180
174-328-40	7/8"	14	482	705	19	55	25	180
174-328-41	7/8"	12	482	705	22	55	25	180
174-328-42	7/8"	14	482	705	22	55	25	180
174-329-09	1"(22)	14	350	650	22	60	28	280
174-329-10	1"(22)	16	350	650	22	60	28	280
174-329-11	1"	14	612	912	25	60	28	280
174-329-12	1"	16	612	912	25	60	28	280
174-331-12	1 1/4"	19	415	765	29	70	31	320

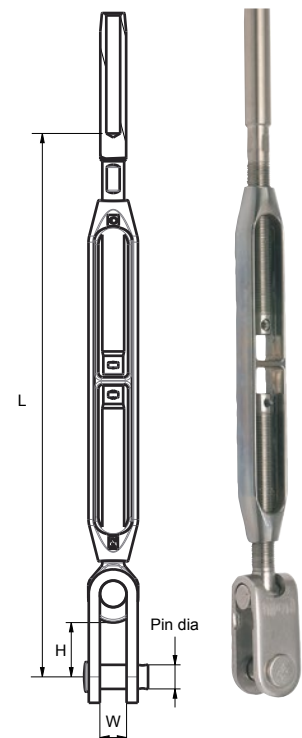

Open + Stemball

Art. No.	Thread size UNF	Radius (R)	Breaking load kN
174-321-18	1/4"	9	15.5
174-321-19	1/4"	11	15.5
174-322-18	5/16"	9	24.5
174-322-19	5/16"	11	24.5
174-322-20	5/16"	14	24.5
174-323-18	3/8"	11	34.5
174-323-19	3/8"	14	34.5
174-324-18	7/16"	11	47.5
174-324-19	7/16"	14	47.5
174-325-18	1/2"	11	62
174-325-19	1/2"	14	62
174-326-18	5/8"	14	95

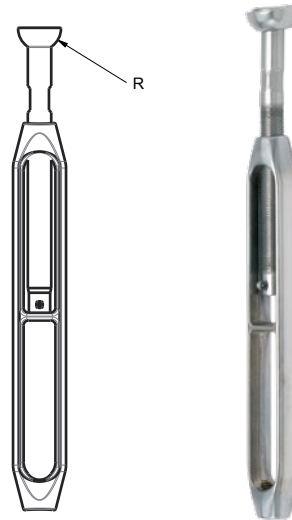

Fork + Stemball

Art. No.	Thread size UNF	Length (L)		Clevis pin dia. mm	Radius (R)	Internal fork height mm (H)	Internal fork width mm (W)	Breaking load kN
		Min. mm	Max. mm					
174-321-34	1/4"	156	220	6.5	9	12	7	15.5
174-321-35	1/4"	156	220	6.5	11	12	7	15.5
174-322-34	5/16"	182	266	8	9	15	8	24.5
174-322-35	5/16"	182	266	8	11	15	8	24.5
174-322-36	5/16"	182	266	8	14	15	8	24.5
174-323-34	3/8"	209	303	9.5	11	18	10	34.5
174-323-35	3/8"	209	303	9.5	14	18	10	34.5
174-324-34	7/16"	244	368	11	11	18	12	47.5
174-324-35	7/16"	244	368	11	14	18	12	47.5
174-325-34	1/2"	280	425	13	11	24	14	62
174-325-35	1/2"	280	425	13	14	24	14	62
174-326-34	5/8"	326	496	15.8	14	31	16	95

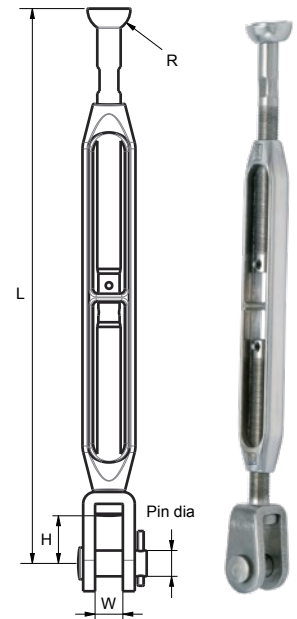

Stemball + Stud terminal

Art. No.	Thread size UNF	Wire dia. mm	Length (L)		Radius (R)	Breaking load kN
			Min. mm	Max. mm		
174-321-15	1/4"	3	161	231	9	15.5
174-321-16	1/4"	3	161	231	11	15.5
174-321-17	1/4"	4	161	231	11	15.5
174-321-23	1/4"	4	161	231	9	15.5
174-322-15	5/16"	5	191	271	9	24.5
174-322-16	5/16"	5	191	271	11	24.5
174-322-17	5/16"	5	191	271	14	24.5
174-323-15	3/8"	6	211	312	11	34.5
174-323-16	3/8"	6	211	312	14	34.5
174-324-15	7/16"	7	248	369	11	47.5
174-324-16	7/16"	7	248	369	14	47.5
174-325-15	1/2"	8	273	418	11	62
174-325-16	1/2"	8	273	418	14	62
174-326-15	5/8"	10	314	484	14	95

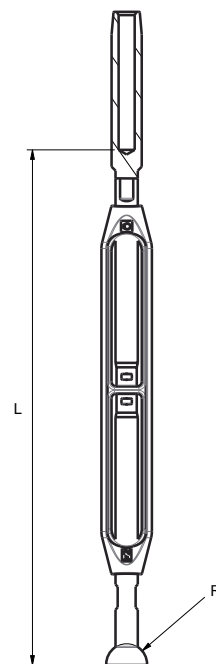

Open + Stud terminal

Art. No.	Thread size UNF	Wire dia. mm	Breaking load kN
174-321-30	1/4"	3	15.5
174-321-31	1/4"	4	15.5
174-322-30	5/16"	4	24.5
174-322-31	5/16"	5	24.5
174-323-30	3/8"	5	34.5
174-323-31	3/8"	6	34.5
174-324-30	7/16"	6	47.5
174-324-31	7/16"	7	47.5
174-325-30	1/2"	7	62
174-325-31	1/2"	8	62
174-326-30	5/8"	8	95
174-326-31	5/8"	10	95
174-327-30	3/4"	10	125
174-327-31	3/4"	12	125
174-328-30	7/8"	12	180
174-328-31	7/8"	14	180

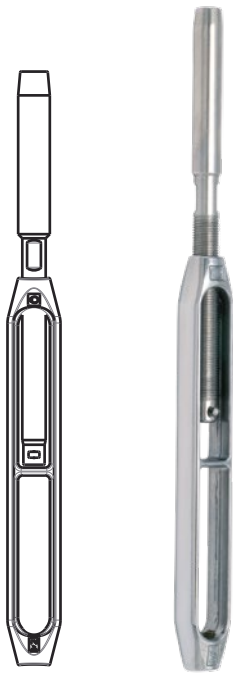

Eye + Stud terminal

Art. No.	Thread size UNF	Wire dia. mm	Length (L)		Eye, Ø mm	Breaking load kN
			Min. mm	Max. mm		
174-321-45	1/4"	3	60	125	6.5	15.5
174-321-46	1/4"	4	60	125	6.5	15.5
174-322-45	5/16"	4	76	149	8	24.5
174-322-46	5/16"	5	76	149	8	24.5
174-323-45	3/8"	5	92	180	10.5	34.5
174-323-46	3/8"	6	92	180	10.5	34.5
174-324-45	7/16"	6	104	225	11.5	47.5
174-324-46	7/16"	7	107	215	11.5	47.5
174-325-45	1/2"	7	117	262	13.5	62
174-325-46	1/2"	8	117	262	13.5	62
174-326-45	5/8"	8	137	307	16.5	95
174-326-46	5/8"	10	137	307	16.5	95
174-327-45	3/4"	10	168	369	19.2	125
174-327-46	3/4"	12	168	369	19.2	125
174-328-45	7/8"	12	195	402	22.5	180
174-328-46	7/8"	14	195	402	22.5	180

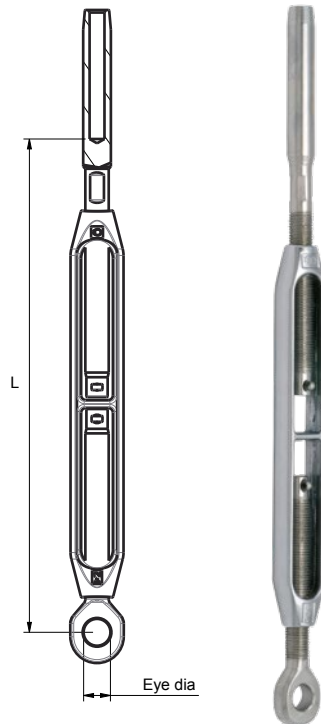

Stud + T-terminal

Art. No.	Thread size UNF	Wire dia. mm	Length (L)		Breaking load kN
			Min. mm	Max. mm	
174-322-21	5/16"	4	118	192	24.5
174-323-21	3/8"	5	135	226	34.5
174-324-21	7/16"	6	149	271	47.5

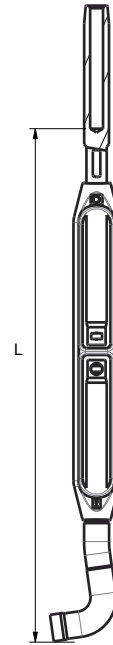

Open + Toggle fork

Art. No.	Thread size UNF	Clevis pin, dia. mm	Internal fork height mm (H)	Internal fork width mm (W)	Breaking load kN
174-321-26	1/4"	6.5	15	7	15.5
174-322-26	5/16"	8	19	9	24.5
174-323-26	3/8"	10	22	11	34.5
174-324-26	7/16"	11	24	12	47.5
174-325-26	1/2"	13	29	14	62
174-326-26	5/8"	15.8	40	18	95
174-327-26	3/4"	15.8	41	20	125
174-328-26	7/8"	19	55	23	180
174-329-27	1"	25	60	28	280
174-331-26	1 1/4"	29	70	31	340

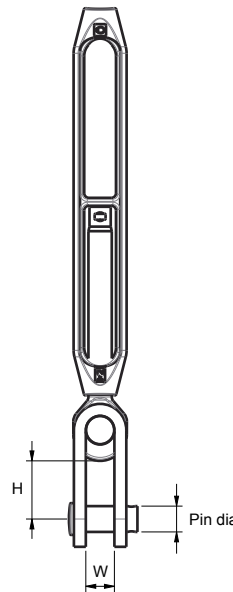

Open + Fork

Art. No.	Thread size UNF	Clevis pin, dia. mm	Toggle fork internal fork height, mm (H ²)	Internal fork width mm (W)	Breaking load kN
174-321-28	1/4"	6	12	7	15.5
174-322-28	5/16"	6	15	8	24.5
174-323-28	3/8"	9	18	10	34.5
174-324-28	7/16"	11	18	12	47.5
174-325-28	1/2"	13	24	14	62
174-326-28	5/8"	15	30	16	95
174-327-28	3/4"	15	32	22	125
174-327-29	3/4"	19	32	22	125
174-328-28	7/8"	19	45	22	180
174-328-29	7/8"	22	45	22	180

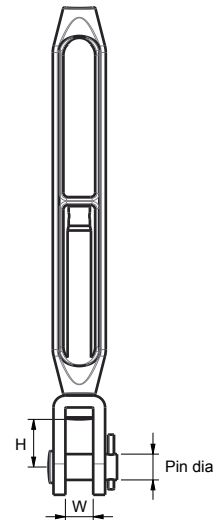

Open + Eye

Art. No.	Thread size UNF	Eye, Ø mm	Breaking load kN
174-324-48	7/16"	11.5	47.5
174-326-48	5/8"	16.5	95

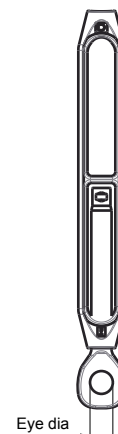

Eye + Eye

Art. No.	Thread size UNF	Length (L)		Eye, Ø mm	Breaking load kN
		Min. mm	Max. mm		
174-324-47	7/16"	205	325	11.5	47.5
174-326-47	5/8"	269	437	16.5	95

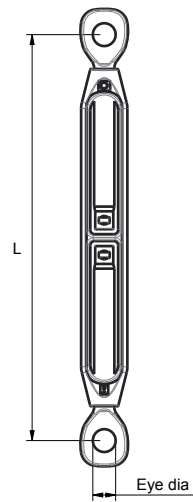

Fork + T-terminal

Art. No.	Thread size UNF	Length (L)		Clevis pin, dia. mm	T dia.	Breaking load kN
		Min. mm	Max. mm			
174-324-22	7/16"	244	365	11	6	47.5

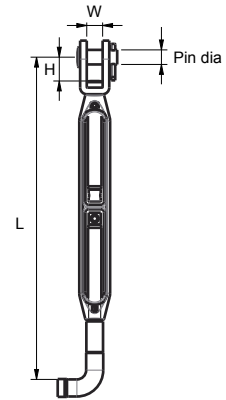

Rigging screw oil

Art. No.	Volume ml
312-502	100



All rigging screws should be lubricated every year.

Backstay adjuster, mechanical

For hydraulic backstay adjusters, see page 128.



Seldén backstay tensioners have smooth, clean surfaces. Even the wire terminal is fully covered. These low-weight backstay tensioners are simple to use. All you do is insert a standard winch handle and turn. The tensioner has a maximum working load of 30 kN. The stroke is an ample 250 or 400 mm, depending on the length of the tensioner. Clevis pins and bushes are supplied with every adjuster to suit small chainplates for Ø 6 and Ø 7 mm wire. When using the backstay adjuster with a Ø 10 mm backstay, the following limitations apply:

- forestay and backstay are both Ø 10 mm, 1 x 19 wire or other stay material with an ultimate strength of 88 kN (8800 kg/19499 lbs) or less
- the backstay-to-mast angle must be at least 40% greater than the forestay-to-mast angle.

Works as a halyard tensioner too

The backstay tensioner can also be used as genoa and main halyard tensioner, suitable for yachts up to 70-80 feet. It is permanently fitted to the mast, and connects directly to the wire halyard. The halyard's detachable rope tail simplifies stowage.



Halyard tensioners.

Backstay tensioners for Ø 6-8 mm wire

Art. No.	Stroke mm	Min/max length, mm	Breaking load, kN	Safe working load, kN
174-601-01	250	518/768	65	30
174-601-02	400	818/1218	65	30

Halyard tensioners

Art. No.	Stroke mm	Min/max length, mm	Breaking load, kN	Safe working load, kN
174-601-03	400	818/1218	65	30

Aluminium rigging screw covers with PVC top-plug

The round rigging screw covers are kind to your sails, sheets and clothing. Nothing can get snagged or chafed on the rigging screws. The rigging screws can be kept well greased, without having to worry about staining the sails or sheets.



Art. No.	For rigging screw	Tube dia., mm outer/inner	Tube length mm	Spare top plug Art. No.
319-580-01	7/16" (6-7 mm)	38/35	650	319-580-02R
319-581-01	1/2" (7-8 mm)	43/40	650	319-581-02R
319-582-01	5/8" (8-10 mm)	50/46	700	319-582-02R
319-583-01*	3/4" (10-12 mm)	57/53	800	319-583-02R
319-584-11**	3/4" (10-12 mm)	67/63	800	319-584-02R
319-584-01	7/8" (12-14 mm)	67/63	1100	319-584-02R
319-585-02	1" (14-16 mm)	87/76	1550	319-585-02R

* For 3/4" rigging screws produced before 2022

** For 3/4" rigging screws produced 2022 -

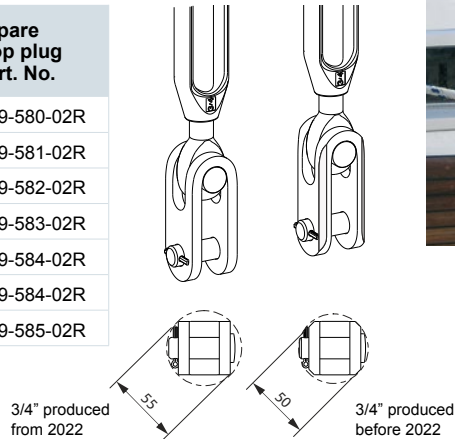

When the backstay has been fully tightened, mark the stay with a piece of tape (see Fig. 1) at the top of the backstay tensioner. The tape marker will enable you to avoid overtensioning. Intermediate values can be marked with different colours.

The length of the split pin should be 1.5 x the diameter of the clevis pin or the threaded terminal. The ends of the pin should be spread approx. 20° apart when the pin is locked (see Fig. 2). To protect the ends, fold a length of tape into a cushion, place the cushion over the ends and wrap the remaining tape a couple of times around the rigging screw (see Fig. 3).

Adjust the rigging screw using two ordinary or adjustable spanners (see picture). Never insert a screwdriver through the body of the rigging screw, as this can seriously damage the screw.



Read more about rigging and tuning in Seldén's publication "Hints and advice".

Fig. 1

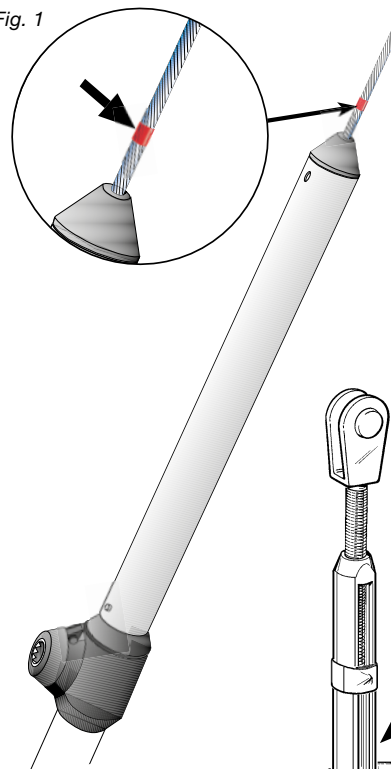

Hints

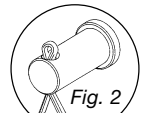

Fig. 2

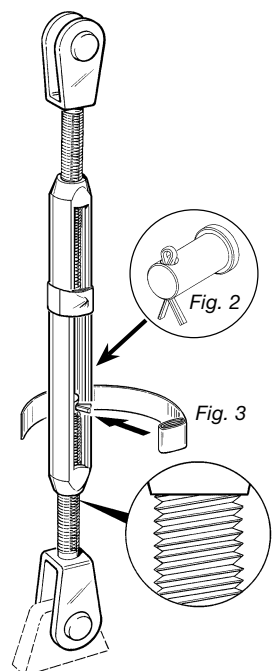

Fig. 3

Fittings

Stud terminals for rigging screws (right-hand thread)



For stainless steel rigging screws, Art. No.	For bronze rigging screws Art. No.	Thread size UNF	Wire mm
308-344	308-344	1/4"	3
308-408	308-408	1/4"	4
308-345	308-345	5/16"	4
308-409	308-409	5/16"	5
308-346	308-346	3/8"	5
308-418	308-418	3/8"	6
308-347	308-347	7/16"	6
308-414	308-414	7/16"	7
308-413	-	1/2"	6
308-348	308-426	1/2"	7
308-349	308-427	1/2"	8
308-385	308-428	5/8"	8
308-419	308-429	5/8"	10
308-386	308-430	3/4"	10
308-420	308-431	3/4"	12
308-421	308-432	7/8"	12
308-422	308-433	7/8"	14
-	308-708	1"	14
-	308-643	1"	16

Eye terminals for metric wire



Art. No.	Wire dia. mm	Eye dia. mm	Eye thickness mm
308-301	3	6.5	3.5
308-302	4	8.3	5.6
308-303	5	10.5	6.6
308-304	6	12.5	7
308-305	7	13.5	7.5
308-330	8	16.5	9.5
308-308	10	16.5	10.8
308-309	12	19.5	16
308-376	14	23	17
308-377	14	25.5	17
308-332	16	25.6	21.2
308-369	19	28.8	25.2
308-369-50	19	32	25.2

Fork terminals for metric wire



Art. No.	Wire dia. mm	Clevis pin dia. mm	Internal fork height mm (H)	Internal fork width mm
308-311-01	3	6.5	12.5	7
308-312-01	4	8	15	8
308-313-01	5	9,5	18	10
308-314-01	6	11	18	12
308-315-01	7	13	24	14
308-316-01	8	15.8	31	16
308-318-01	10	15.8	32	21.5
308-319-01	12	19	39	21.5
308-590-01	14	22	45	22
308-384-01	16	25.5	50	25.5
308-740-01*	19	28.5	70	31

* Toggle terminal

Lifeline terminal with removable fork



Art. No.	Wire dia. mm	Clevis pin dia. mm	Internal fork height mm (H)	Internal fork width mm
308-339-01	3	6.5	12.5	7
308-337-01	4	8	15	8
308-338-01	5	9.5	18	10

Stemball terminal and washers

Wire diameter, mm	Art. No. Terminal+cups (radius)	Art. No. Terminal (radius)	Art. No. Cups (inner/outer radius)	Art. No. Cups (inner/outer radius)
3	308-550-03 (R9)	308-550 (R6)	306-594 (R6/9)	-
	308-550-04 (R11)			306-572 (R9/11)
4	308-558 (R9)	308-558 (R9)	-	-
	308-558-04 (R11)			306-572 (R9/11)
	308-558-01 (R14)			306-573 (R11/14)
5	308-552 (R9)	308-552 (R9)	-	-
	308-552-04 (R11)			306-572 (R9/11)
	308-552-01 (R14)			306-573 (R11/14)
6	308-553 (R11)	308-553 (R11)	-	-
	308-553-01 (R14)			306-573 (R11/14)
	308-553-02 (R18)			306-574 (R14/18)
7	308-554 (R11)	308-554 (R11)	-	-
	308-554-01 (R14)			306-573 (R11/14)
	308-554-02 (R18)			306-574 (R14/18)
8	308-555 (R14)	308-555 (R14)	-	-
	308-555-02 (R18)			306-574 (R14/18)
	308-555-05 (R22)			306-595 (R18/22)
10	308-556 (R14)	308-556 (R14)	-	-
	308-556-02 (R18)			306-574 (R14/18)
	308-556-05 (R22)			306-595 (R18/22)
12	308-557 (R18)	308-557 (R18)	-	-
	308-557-05 (R22)			306-595 (R18/22)
14	308-559 (R22)	308-559 (R22)	-	-



Stemball terminals

for rigging screws (Left-hand thread, Stemball cups – see page 37)

Art. No.	For rigging screws	Radius
308-560	1/4"	6
308-561	5/16"	9
308-562	3/8"	9
308-563	7/16"	11
308-564	1/2"	11
308-565	5/8"	14
308-566	3/4"	18
308-567	7/8"	18

T/Eye toggle for rope runners

Wire dia., mm	Art. No.
3	174-136
4	174-137
5	174-138
6	174-139
7	174-140
8	174-141



When replacing traditional wire runners with lightweight runners, in for example Dyneema, keep your existing backing plate and add a T/Eye toggle.

Sta-lok wedge for compact ("Dyform") wire

When re-using a Sta-lok wire terminal, the wedge needs to be replaced.

Art. No.	Wire dia. mm
301-622-01	5
301-623-01	6
301-624-01	7
301-625-01	8
301-626-01	10
301-627-01	12
301-628-01	14
301-629-01	16



Wire terminal Sta-lok®



Art. No.	For wire dia. mm	Type of terminal
301-117	4	Eye
301-118	5	
301-119	6	
301-120	7	
301-121	8	
301-122	10	
301-123	12	
301-124	14	
301-633	14L	
301-132	16	
301-125	4	Fork
301-126	5	
301-127	6	
301-128	7	
301-129	8	
301-130	10	



Sta-lok wedge for 1x19 wire

When re-using a Sta-lok wire terminal, the wedge needs to be replaced.

Art. No.	Wire dia. mm
301-150	4
301-151	5
301-152	6
301-153	7
301-154	8
301-155	10
301-156	12
301-162	14
301-613	16



Stud Sta-lok®

Art. No.	Wire dia. mm	Thread size UNF
308-434	3	1/4"
308-435	4	1/4"
308-436	4	5/16"
308-437	5	5/16"
308-438	5	3/8"
308-439	6	3/8"
308-440	6	7/16"
308-441	6	1/2"
308-442	7	7/16"
308-443	7	1/2"
308-444	8	1/2"
308-445	8	5/8"
308-446	10	5/8"
308-447	10	3/4"
308-448	12	3/4"
308-449	12	7/8"
308-450	14	7/8"
308-455	14	1"
308-575	16	1"



Lifeline Pelican hook terminal

Art. No.	Wire dia. mm
174-356	4
174-357	5





T-terminals for metric wire

Art. No.	Wire dia. mm	Lateral shroud angle
308-321	3	Max 20°
308-322	4	Max 20°
308-323	5	Max 20°
308-328	5	18° - 25°
308-324	6	Max 20°
308-329	6	18° - 25°
308-325	7	Max 20°
308-326	8	Max 20°
308-327	10	Max 20°



Backing plates

for T-terminal (see also pages 22)

Art. No.	Wire dia. mm	Rod	Remarks
507-553-01	3	-	
507-551-01	4	-3	
507-552-01	5	-4	
507-600-01*	6	-6	
507-601-01*	7	-8	
507-582-01*	8	-10, -12	C174-C245
507-583-01*	10	-15, -17	C227
507-583-02*	10		C245
507-583-03*	10		C264
507-583-04*	10		C285-C304
507-583-05*	10		F-228-F305

* Use only as shroud attachment.

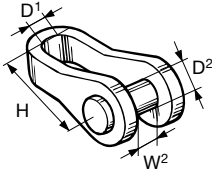
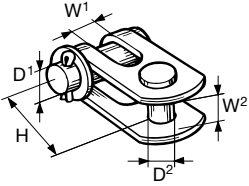
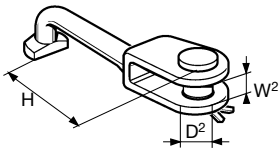
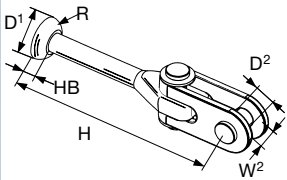
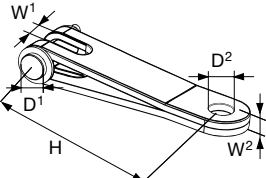

Toggles

Eye/fork toggle	Forestay dia., mm	Art. No.	Length H mm	Ø Clevis pin D ² mm	Fork width W ² mm	Ø Eye D ¹ mm	For rigging screw diam	
 <p>Can be used to lengthen a Furlex system. Fit it underneath the standard fork/fork toggle or at the top end of the Furlex wire.</p>	3	174-101-01	21	6.5	7	7	1/4"	
	3, 4	174-102-01	26	8	8	8	5/16"	
	5	174-103-01	33	9.5	10	10	3/8"	
	6	174-104-01	39	11	12	12	7/16"	
	7	174-105-01	43.5	13	14	14	1/2"	
	8	174-106-01	49.5	15.8	16	16	5/8"	
	10	174-107-01	65	15.8	22	16	3/4"	
		174-132-01	65	19	22	16	3/4"	
	12	174-125-01	95	19	22	20	7/8"	
		174-134-01	91	19	22	22.5	7/8"	
	14	174-133-01	95	22	22	23	7/8"	
	174-135-01	91	22	22	23	7/8"		
16	174-126-01	120	22	25	23	M24		
Standard Furlex fork/fork toggle	Forestay dia., mm	Art. No.	Length H mm	Ø Clevis pin D ¹ mm	Ø Clevis pin D ² mm	Fork width W ¹ mm	Fork width W ² mm	
	4	517-056-02	25	8	8	7.5	8.5	
	5	517-054-02	30	10	10	10	11	
	6	517-046-02	40	12	10	11	11	
	7	517-047-02	40	12	12	11	12.5	
	8	517-048-02	50	14	14	14	12.5	
	10	517-060-04	55	16	16	14	16	
	12	517-052-02	65	19	19	20.5	21	
	14	517-053-02	80	22	22	20.5	23	
16	517-074-02	85	25	22	22	26		
T/fork toggle	Forestay dia., mm	Art. No.	Length H mm	Ø Clevis pin D ² mm	Fork width W ² mm			
 <p>Needed to connect the Furlex to a Seldén backing plate for T-terminals.</p>	4	174-127-01	68	8	8			
	5	174-128-01	80	9.5	10			
	6	174-122-01	93	11	12			
	7	174-123-01	100	13	14			
	8	174-124-01	112	15.8	16			
Stemball/eye toggle with fork/fork toggle	Forestay dia., mm	Art. No.	Length H mm	Ø Clevis pin D ² mm	Fork width W ² mm	Height HB mm	Radius R mm	Ø Stemball D ¹ mm
 <p>Needed when fitting Furlex to some masts of other origin than Seldén.</p>	5	517-065-01	138	10	11	8.5	10	26
	6	517-066-01	152	10	11	8	10	26
	7	517-097-01	153	12	12.5	11	13	26
	8	517-068-01	197	14	15.5	9	15	34
	10	517-068-02	202	16	16	9	15	34
	12	517-069-01	226	19	21	8.5	15	34
Eye/fork extension link*	Forestay dia., mm	Art. No.	Length H mm	Ø Clevis pin D ¹ mm	Fork width W ¹ mm	Ø Eye D ² mm	Gauge W ² mm	
	4	517-944-01	90	8	7	8	4	
	5	517-945-01	90	10	9.5	10	4	
	6/7	517-063-01	90	12	11	12	6	
	8/10	517-062-01	130	16	14	16.5	10	
	12	517-075-01	190	19	20.5	20	12	
	14	517-076-01	190	22	20.5	22.5	16	

* If the boat is fitted with a bow anchor, it may be necessary to permanently raise the lower bearing assembly for anchor clearance. A selection of extension links are available. If the lower bearing assembly is raised by means of an extension link, a Furlex fork/fork toggle, should be fitted between the link and the forestay attachment. This in order to secure proper articulation in all directions.

Split pins, split rings and clevis pins for rigging screws



Split pins

Art. No.	Diameter x length, mm	For rigging screw dia.	For fork terminal, wire dia., mm
301-003	2.5 x 12	1/4"	3
301-004	2.5 x 15	5/16", 3/8"	4, 5
301-011	3.2 x 20	7/16", 1/2"	6, 7
301-020	3 x 25	5/8", 3/4"	8, 10
301-051	3.7 x 25 (28)	5/8", 3/4"	8, 10, 12
301-007	4.6 x 38	7/8"	12, 14
301-029	4 x 30	3/4", 7/8"	12
301-522	4 x 40	7/8", M24	14
301-036	5 x 50	M24	-



Clevis pins

Art. No.	For rigging screw and toggle dia.	For fork terminal wire dia., mm	For life line terminal wire dia., mm	Diameter mm	Length = L mm
168-010	1/4"	3	3	6.5	17.5
168-011	5/16"	4	4	8	20.5
168-012	3/8"	5	5	9.5	23
168-013	7/16"	6		11	28
168-014	1/2"	7		13	32
168-021*	5/8"	8		15.8	38
168-022	3/4"	10		15.8	45
168-023	3/4"	12		19	45
168-018	7/8"			19	54
168-024	7/8"	14		22	54
168-025	M24			22	60
168-015*				13	40
168-019*				11	40

* = Included in backstay tensioners and halyard tensioner Art. No. 174-601-01, 174-601-02 and 174-601-03.

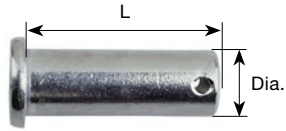

Clevis pins stainless steel

Art. No.	Dia. mm	Length mm	Matching dia. of split pin, mm
165-601	5	28	1.8
165-603	5	34	
165-604	5	41	
165-606	5	47	
165-005	6	26	
165-006	6	30	
165-007	6	36	2.3
165-101	8	18	
165-103	8	22	
165-113	8	27	
165-105	8	32	
165-107	8	36	
165-128 (D-bolt)	8	40	
165-108	8	50	
165-119	8	55	
165-118	8	63	
165-112	8	70	
165-127	8	80	
165-202	10	22	
165-203	10	28	
165-212	10	24	
165-205	10	32	
165-221	10	35	
165-211	10	40	
165-207	10	42	
165-129 (D-bolt)	10	45	
165-208	10	46	
165-206	10	50	
165-213	10	58	
165-216	10	79	
165-209	10	97	
165-401	12	25	2.9
165-402	12	33	
165-409	12	37	
165-405	12	41	
165-404	12	46	
165-403	12	53	
165-410	12	61	
165-411	12	137 (hole Ø5)	4.6
165-412	12	150 (hole Ø5)	
165-413 (D-bolt)	12	61 (hole Ø4.5)	3.7
165-415	12	162 (hole Ø5)	4.6
165-501	14	31	3.7
165-504	14	35	
165-505	14	41	
165-503	14	49	
165-502	14	53	
165-507	14	61	
165-557	5/8"	30	
165-558	5/8"	33	
165-560	16	34	
165-554	16	37	
165-552	16	50	
165-555	16	57	
165-556	16	69	
165-551	16	76	
165-559 (D-bolt)	16	76 (hole Ø 5.5)	4.6
165-581	19	42	
165-582	19	60	
165-584	19	84	
165-594	22	49	
165-595	22	60	
165-597	1"	102	5.9
165-598	1"	66	
165-586	25	82	

Split rings



Art. No.	Diameter x thickness, mm	For rigging screw dia.
301-014	16 x 1	1/4", 5/16", 3/8"
301-015	20 x 1,5	7/16"
301-016	25 x 1,5	1/2", 5/8"
301-017	13,5 x 1,5	
301-027	10 x 1,5	
301-028	15 x 1,5	



Split pins stainless steel

Art. No.	Dia., mm	Length, mm
301-046	1,8	10
301-047	2,3	12
301-048	2,3	16
301-006	2,3	25
301-049	2,9	16
301-050	2,9	18
301-013	2,9	24
301-044	2,9	27
301-011	3,2	20
301-061	3,7	18
301-053	3,7	20
301-051	3,7	25
301-045	3,7	33
301-062	3,7	40
301-010	3,7	50
301-054	4,6	28
301-055	4,6	33
301-007	4,6	38
301-057	5,9	37
301-059	5,9	43
301-058	5,9	45
301-060	5,9	48

The recommended length of the split pin is approx. 1.5 x the diameter of the clevis pin.

Sheaves composite

Art. No.	Outer dia. mm	Hole dia. mm	Width mm	Max. rope dia. mm	Max. rope/wire dia., mm
504-310 (PA)	23	6	10	8	–
504-319	28	8	13	10	–
504-316	28	10	13	12	10/4
504-505	38	10	11	10	–
504-320	45	8	13	10	8/3
504-321	45	10	13	12	10/4
504-502	45	12	16	14	12/5
504-504	45	10	11	10	–
504-322	57	8	13	12	10/4
504-323	57	10	13	12	10/4
504-324	57	12	13	12	10/4
504-348	57	14	13	12	10/4
504-382	57	14	11	8	–
504-325	70	10	13	12	10/5
504-326	70	12	13	12	10/5
504-332	70	12	16	16	12/6
504-327	70	14	13	12	10/5
504-333	70	14	16	14	10/6
504-334	70	16	16	14	10/6
504-328	90	10	13	12	10/6
504-329	90	12	13	12	10/6
504-335	90	12	16	16	14/7
504-330	90	14	13	12	12/7
504-336	90	14	16	16	14/7
504-337	90	16	16	16	14/7
504-338	90	20	20	20	16/8
504-339	130	20	20	20	16/8

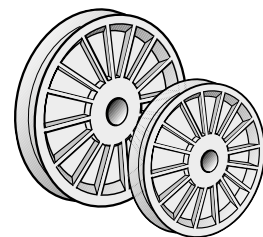
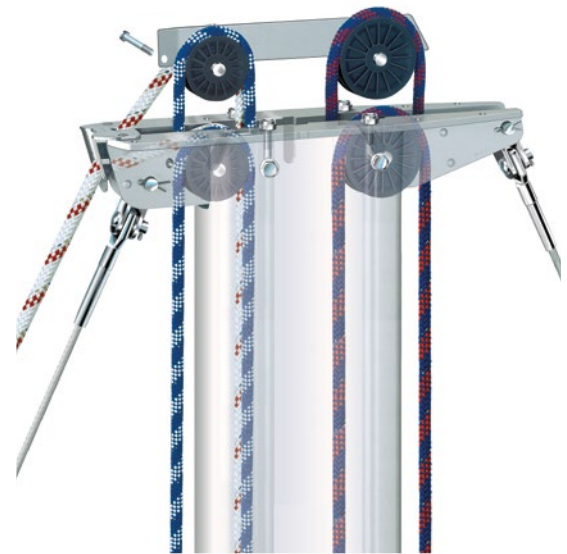

Bridle plates

Wire, dia., mm (perm. backstay)	Art. No.	Hole dia., mm
4, 5	528-005-01	3 x Ø10
6, 7	528-006-01	3 x Ø12
8	528-013-01	2 x Ø14 + 1 x Ø16
10	528-033-01	3 x Ø16
12	528-032-01	2 x Ø16 + 1 x Ø20
14	528-035-01	2 x Ø20 + 1 x Ø23

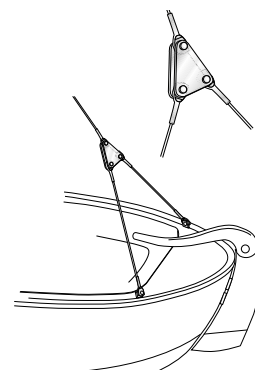

Insulators

Convert your wire backstay to a short wave antenna with one insulator at each end.

Wire, dia. mm	Art. No.	Nylon
		Isolator + 2 talurit-eyes, Art. No.
7	319-524	319-524-01
8	319-524	319-524-02



All experienced sailors appreciate smart solutions and features that simplify sail handling and life on board in general. Sometimes they are the most obvious items like furling gear, Rodkickers and single line reef booms. Other times, they can be less self-evident, the things you tend not to think about, but appreciate even more when you use them.

We, ourselves, are experienced sailors. You'll find some of our favourite solutions on the following pages of this "Just Smart" section. We hope they will become yours, too.

JUST SMART



Backstay flicker	184
Lazyjacks system	184
Rigging screw covers	185
Mast climbing steps	186
Cutter stay stowage	186
Trysail system	187
Cable glue	188
Sealing kits	188
Winch handle pocket	189

Backstay flicker

– gives the mainsail space to move

The backstay flicker is a glass fibre rod fitted to the head box on a fractional rig with swept spreaders. It lifts up a wire or rope backstay to allow for free passage of a full roach mainsail.



The backstay flicker comes complete with fasteners and backstay block.

Complete kit with fasteners and instruction for assembly

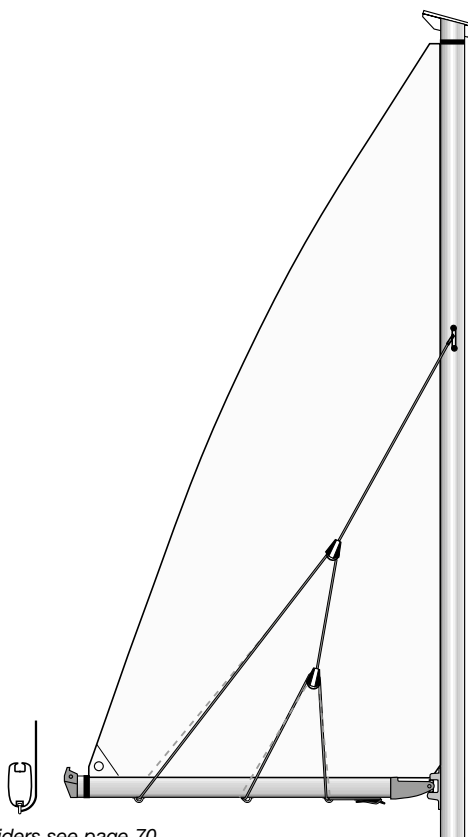
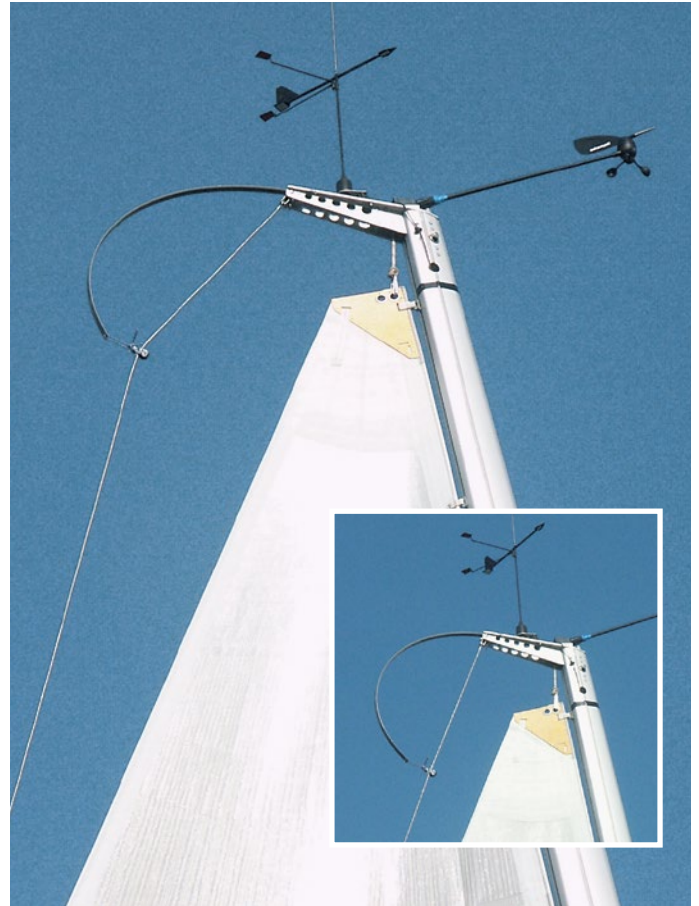

Art. No.	Batten length, mm	Boat size, ft
511-120-01	1200	< 30 fot
511-121-01	1400	30-37 fot
511-123-01	1800	37-43 fot



Lazyjack sliders see page 70.

Lazyjack – contains the mainsail

A lazyjack system is an active aid for containing the mainsail when reefing and dousing. Our lazyjack system works exceptionally well with fully-battened mainsails, but it is also very handy for use with conventional sails. Seldén supplies complete lazyjack kits with all the necessary blocks, eye straps, lines, fasteners, boom sliders and full instructions.

Description	Art. No.	Boom sections	Remarks
 2-leg system	511-636-05R	120/62-171/94	P _{max} = 12 m
	511-637-05R	200/117-250/140	
 3-leg system	511-636-06R	120/62-171/94	P _{max} = 20 m
	511-637-06R	200/117-250/140	



Aluminium rigging screw covers with PVC top-plug

The round rigging screw covers are kind to your sails, sheets and clothing. Nothing can get snagged or chafed on the rigging screws. The rigging screws can be kept well greased, without having to worry about staining the sails or sheets.

Art. No.	For rigging screw	Tube dia., mm outer/inner	Tube length mm	Spare top plug Art. No.
319-580-01	7/16" (6 mm)	38/35	650	319-580-02R
319-581-01	1/2" (7 mm)	43/40	650	319-581-02R
319-582-01	5/8" (8 mm)	50/46	700	319-582-02R
319-583-01	3/4" (10 mm)	57/53	800	319-583-02R
319-584-01	7/8" (12 mm)	67/63	1100	319-584-02R
319-585-02	1" (14-16 mm)	87/76	1550	319-585-02R

Mast climbing steps – for extra climbing safety

Mast climbing steps are an easily fitted safety feature. Seldén mast climbing steps are available as fixed steps (an outer guard wire can be used for extra safety) or as foldable climbing steps. The well-rounded shape of the foldable steps reduces windage and sail chafe.

 Always use a safety harness when working aloft.

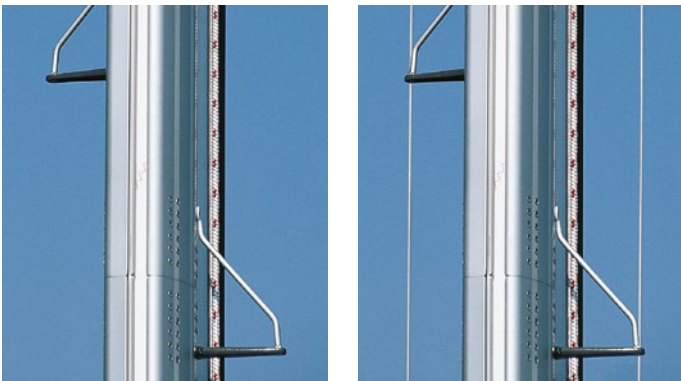

Climbing steps, fixed

Art. No.	Radius	Mast section
508-539-01	R155	E138-E274 D121-D160
508-565-01	R300	C321, E365 All furling masts All C-sections and F-sections

Climbing steps, foldable

Art. No.	Radius	Mast section	Remarks
508-183-03	R290	All furling masts C321, E365	Incl. screw, for wall thickness > 4 mm
508-183-04		All C-sections	Incl. rivets, for wall thickness < 5 mm
508-185-03	R122	E170-E274 D137-D160	Incl. screw, for wall thickness > 4 mm
508-185-04			Incl. rivets, for wall thickness < 5 mm

Hint: With a foldable mast step 0.5 m up from deck, it will be a lot easier to attach the halyard to the head of the mainsail.

Cutter stay spreader hook Cutter stay stowage bracket

With a Seldén cutter stay spreader hook mounted on the spreader, and a cutter stay stowage bracket mounted on the mast, your cutter stay will always be ready for use, stand-by secured by its pelican hook (or similar) to a deck bracket. Safely out of the way until you actually need it!

The hook can also be used to park a halyard.

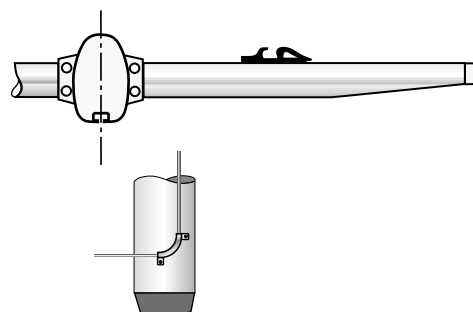

Cutter stay spreader hook,
Art. No. 508-190-01.

Cutter stay stowage bracket,
Art. No. 508-225-01.

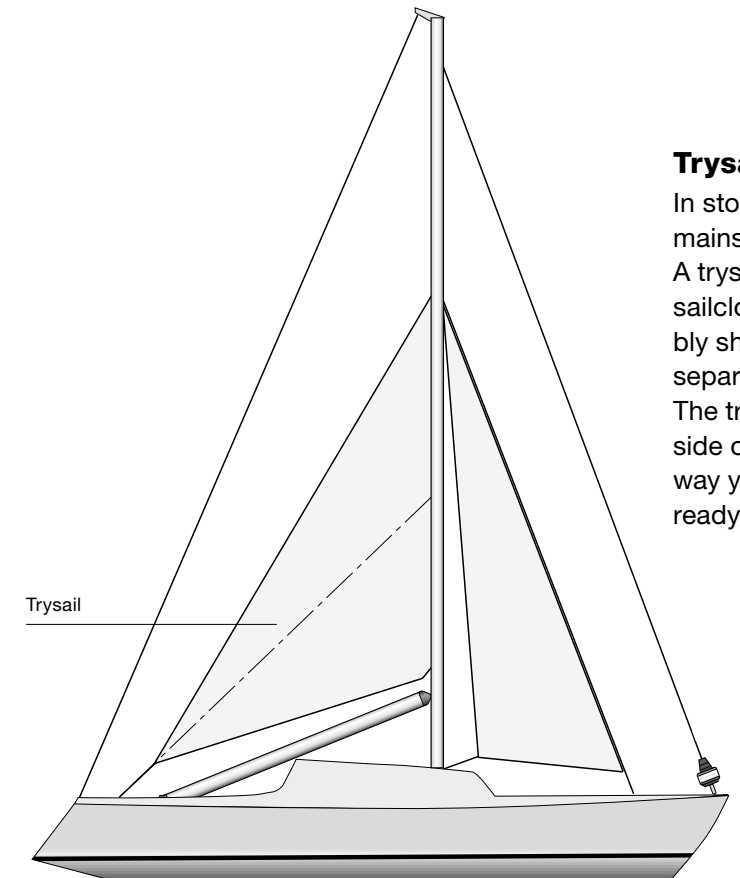

Trysail system

In stormy weather, when your 2nd or 3rd reef of the mainsail just isn't enough, the way to go is with a trysail. A trysail is a loose-footed, fairly flat sail made from heavy sailcloth, but with a luff length and foot length considerably shorter than your regular mainsail. It is hoisted on a separate track, independent of the normal luff groove. The trysail track is fitted beside the luff groove on the aft side of the mast and runs all the way to deck level. That way you can always have your trysail fitted to the track, ready to be used.

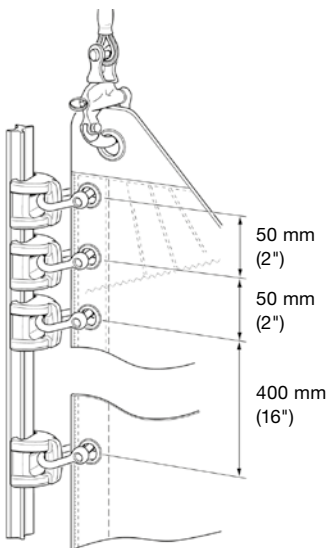

When using a trysail, the end of the main boom is secured to the deck. Sheeting point should be according to the illustration.

If trysail luff length is not available from the yacht designer, our general recommendation is that the trysail should reach 55-65% of the foretriangle height. The track should end approximately 0.5 m below checkstays/ runner attachments, if any.

We recommend fitting three sliders at the head and tack of the sail (c/c 50 mm), remaining sliders to be fitted c/c 400 mm.

Seldén Silicone lubricant (Art. No. 312-506) can be used on the track to minimise friction.



Trysail with track gate, end stop, sliders and fasteners. Art. No. 515-525-31.

Tracks and sliders

Mast section	RCB 22 track L = 2300 mm incl. pop rivets and 6 trysail sliders	Trysail gate track, end stops, fasteners 12 trysail sliders	Separate sliders
All E-, D- and R-profiles C227-C304 F212-F305	515-525-35	515-525-31	511-713

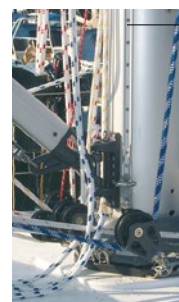

Track

At your service

Cable glue

In masts not featuring a dedicated cable conduit, you need to fix your cables with glue. We provide a PU glue (Cascol 1809) complete with instructions.

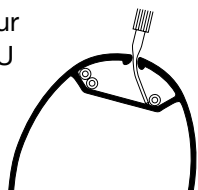

Gluing cables.



Art. No. 312-301-03.

Mast section	300 ml glue and instructions, Art. No.
Older E-sections and P-sections	312-301-03

Sealing kits



Art. No. 312-322-10.



Art. No. 312-301-02.

Type of sealing	Instruction	Sealing kit, Art. No.
Sealing of open conduits	595-548-E	312-301-02
Secondary sealing of a keel-stepped mast	595-814-E	312-322-10



Locking adhesive, Art. No. 312-305.



Lubrication for Torton® ball bearings, Art. No. 312-534.



Rigging screw oil, (15 bottles/box) Art. No. 312-502.



Lubricating grease, (16 tubes/box) Art. No. 312-501.

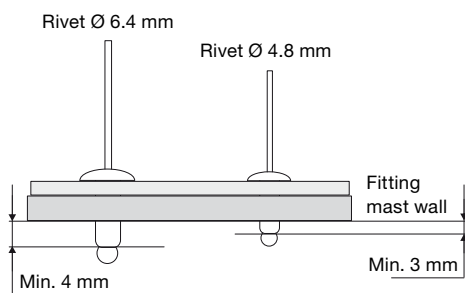

Domed or counter sunk head

Pop rivet

Art. No	Dim., Ø mm	Length, mm	Material	Head
167-007	4.8	9.9	Monel	Domed
167-018	4.8	12.7	Monel	Domed
167-022	4.8	12.7	Monel	Counter sunked
167-006	4.8	16.5	Monel	Domed
167-005	4.8	20.3	Monel	Counter sunked
167-008	4.8	25.4	Aluminium	Domed
167-004	6.4	12.7	Monel	Domed
167-003	6.4	14.5	Monel	Counter sunked
167-002	6.4	17.8	Monel	Domed

Monel® = a highly corrosion resistant nickel alloy commonly used with aluminium in harsh environments.



Pop rivet gun for Ø 3.25-6.5 mm aluminium or monel rivets. Art. No. 592-003.

Winch handle pocket

The Seldén winch handle pocket is suitable for most modern winch handles. The pocket has a drainage hole and is easy to fit on both flat and curved surfaces, on the mast or in the cockpit.



Art. No. 533-925-01 (incl. pop-rivets)

Stanchion blocks for Furlex

Fit Ø 25-30 mm stanchions.

Art. No. 538-210-02R
For Furlex 304S/TD and
404S/TD.



Art. No.538-971-01
For Furlex 50S, 104S, 204S/TD and 304S/TD.

Seldén worldwide



Seldén is represented worldwide by more than 750 authorised dealers. We use comprehensive information material, manuals and films to impart our quality thinking to dealers and service centres. We arrange regular dealer training courses to enable our dealers to live up to our requirements for technical expertise and gain a full understanding of the Seldén product philosophy. Our strong local presence on all marine markets means that yachtsmen can access spare parts and know-how wherever they are.

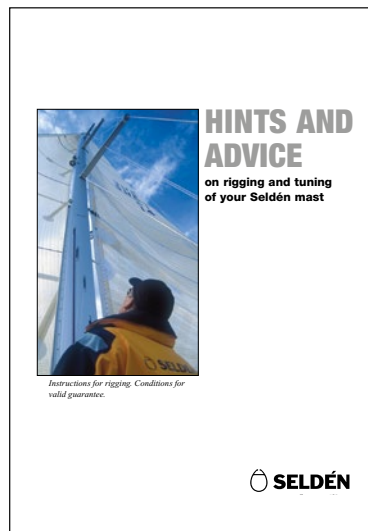

Art. No. 595-540-E

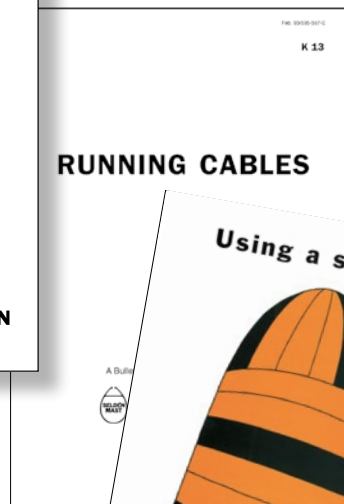

Art. No. 595-557-E



Art. No. 595-560-E

Useful publications

Our well known “Hints and advice”, for example, is regarded as an essential part of any yachting library. Download the Seldén publication you need from www.seldenmast.com

Conversion factors

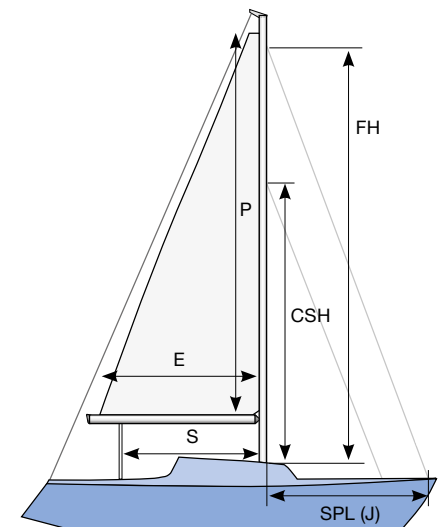

E = Mainsail foot length
 P = Mainsail luff length
 S = Main sheet distance from mast
 FH = Forestay height
 CSH = Cutter stay height
 SPL (J) = Spinnaker pole length

	Multiply number of	by	to obtain equivalent number of	Multiply number of	by	to obtain equivalent number of
Length	Inches (in)	25.4	millimetres (mm)	Millimetres	0.03937	inches
	Inches (in)	2.54	centimetres (cm)	Centimetres	0.3937	inches
	Feet (ft)	30.48	centimetres (cm)	Metres	39.3701	inches
	Feet (ft)	0.3048	metres (m)	Metres	3.2808	feet
Area	Sq. inches (in ²)	645.16	sq. millimetres (mm ²)	Sq. millimetres	0.00155	sq. inches
	Sq. inches (in ²)	6.4516	sq. centimetres (cm ²)	Sq. centimetres	0.1550	sq. inches
	Sq. feet (ft ²)	929.0304	sq. centimetres (cm ²)	Sq. metres	10.7639	sq. feet
	Sq. feet (ft ²)	0.092903	sq. metres (m ²)	Sq. metres	1.19599	sq. yards
	Sq. yards (yd ²)	0.836127	sq. metres (m ²)			
Weight	Ounces (oz)	28.3495	grams (g)	Grams	0.03527	ounces
	Pounds (lb)	453.59237	grams (g)	Kilograms	35.274	ounces
	Pounds (lb)	0.4536	kilograms	Kilograms	2.20462	pounds

Notes



Photo credits:	Pages:	Photo credits:	Pages:
Anders Averdal	118-119	Niklas Axhede	108-109, 154
Michael Amme	4, 158	RS Sailing	15
John Corby	60	Billy Black	8-9, 110
Leif Wiklund	studio pictures	Rustler Yachts	7
Rickard de Junge	134	Sander van der Borch	9, 56-57
Seldén Mast AB	6	Petter Abrahamsen	12-13
Stefan Ljungstedt	178-179	Search Magazine	27
Hervé Favre	55	Tjelvar Ericsson	96, 97, 112
Axel Nissen-Lie	126, 131		
Peter Szamer	48, 53, 69, 78-79, 84		
Dan Ljungsvik	Cover, 5, 11, 16, 28, 33, 39, 44, 47, 50, 51, 63, 65, 71, 75, 80-81, 86, 88-89, 92, 102, 104, 105, 106, 122-123, 124, 125, 126, 130, 132-133, 134-135, 136, 137, 140-141, 143, 144, 145, 147, 148, 149, 150, 151, 163, 164-165, 166, 172, 177, 182-183, 185, 191.		

DINGHIESKEELBOATSYACHTS

Seldén Mast AB, Sweden

Tel +46 (0)31 69 69 00
Fax +46 (0)31 29 71 37
e-mail info@seldenmast.com

Seldén Mast Limited, UK

Tel +44 (0)1329 50 40 00
Fax +44 (0)1329 50 40 49
e-mail info@seldenmast.co.uk

Seldén Mast Inc., USA

Tel +1 843-760-6278
Fax +1 843-760-1220
e-mail info@seldenus.com

Seldén Mast A/S, Denmark

Tel +45 39 18 44 00
Fax +45 39 27 17 00
e-mail info@seldenmast.dk

**Seldén Mid Europe B.V.,
Netherlands**

Tel +31 (0)111-698 120
Fax +31 (0)111-698 130
e-mail info@seldenmast.nl

Seldén Mast SAS, France

Tel +33 (0)251 362 110
Fax +33 (0)251 362 185
e-mail info@seldenmast.fr

**Seldén Mast Asia Ltd,
Hong Kong**

Tel +852 3572 0613
Fax +852 3572 0623
e-mail info@seldenmast.com.hk

seldenmast.com

The Seldén Group is the world's leading manufacturer of mast and rigging systems in carbon and aluminium for dinghies, keelboats and yachts. Since 2008 the product range has been extended with deck hardware, winches and sailmaker hardware.

The Group consists of Seldén Mast AB in Sweden, Seldén Mast A/S in Denmark, Seldén Mast Ltd in the UK, Seldén Mid Europe B.V. in the Netherlands, Seldén Mast SAS in France, Seldén Mast Inc. in the USA and Seldén Mast Asia Ltd in Hong Kong.

Our well known brands are Seldén and Furlex. The worldwide success of Furlex has enabled us to build a network of over 750 authorised dealers covering the world's marine markets. So wherever you sail, you can be sure of fast access to our service, spare parts and know-how.

SELDÉN and FURLEX are registered trademarks of Seldén Mast AB.